

Environmental Report 2015

Contents

Foreword	1
Company portrait and business model	4
Copper – a sought-after metal	6
Closing the loop – thinking in terms of cycles	7
Copper – the material of modern life	8
Climate protection in practice	9
Corporate environmental protection principles	10
Environmental protection in the Aurubis Group	11
Environmental protection – facts and figures	16
Sustainability as part of the corporate strategy	18
Energy efficiency and energy management	20
The environmental footprint of products and organizations	22
Recycling and resource efficiency	24
For the environment: close cooperation with policymakers, authorities and associations	26
Environmental protection milestones at the Pirdop site	28
Stakeholder dialogue	32
Technical Environmental Protection	34
Environmental management	36
Site Reports	38
Glossary	70
Contact information and imprint	73



The title photo is a close-up of a copper surface from Aurubis Finland's "Nordic Products" series, an example of Aurubis copper in architecture, www.aurubis.com/finland/architectural/nordic-products

Dr. Bernd Drouven:

»Resource efficiency is an important concern for us. We want more and can do more in this area.«



Dear readers,

I'm pleased to present our Environmental Report 2015. Aurubis is oriented to growth and enhancing value, engaging in sustainable economic activities in the process. This means that it is a matter of course for us to utilize resources responsibly. For example, our qualified multi-metal recycling ensures that as little as possible is lost and as much as possible is reusable. We are working on further minimizing the environmental impacts of production processes, and we are one of the most environmentally friendly copper producers in the world.

Our sustainable business strategy should also enable us to assume a stable position in the dynamic international markets. In fiscal year 2013/14 we improved consolidated earnings compared to the previous year, which had generated weak earnings. We have other aspirations in this area, even though the environment was undoubtedly difficult. Various factors – slowing economic momentum in the emerging markets, the effects of the debt crisis in Europe, falling prices on the raw material markets, conflicts in Ukraine – led to uncertainty, which also influenced our markets.

The goals of our 2018 strategy are ambitious and include enhanced production expertise, a multi-metal focus in the raw material supply and processing, a stronger customer and supplier orientation, full utilization of synergies in our value chain, further internationalization of the Group and sustainable conduct and economic activity. We want to face the changes of the coming years with this strategy and push the Group further on a stable economic foundation. Our goal is to continue securing the future – with a responsible business approach.

To conclude, I want to make sure that I give the employees my warmest thanks for their commitment at the individual sites – without the strong cooperation between the local Environmental Officers, the Plant Managers and the Corporate Environmental Protection Department, the continuous improvement in Aurubis' environmental performance wouldn't be possible. The voluntary involvement of the many employees who regularly and actively promote environmental protection, for example with good ideas or as part of the "Green Project" in Pirdop, should be emphasized in particular. For me, responsibility means taking on tasks for the company, even outside of one's own department.

See environmental protection at Aurubis for yourself and feel free to join in the dialogue with us.

Best regards,

A handwritten signature in black ink, appearing to read 'Bernd Drouven', written in a cursive style.

Dr. Bernd Drouven

CEO and Executive Board Member for Business Unit Primary Copper

July 2015

Dear readers,

Aurubis is one of the leading international copper groups and would like to continue expanding this market position. We process copper and other metallic raw materials with state-of-the-art techniques and fabricate products of the highest quality. Copper is our key expertise, but other metals are also becoming increasingly important. With our corporate philosophy and consistent capital expenditure, we are one of the most environmentally friendly copper producers in the world as well as the largest multi-metal recycler.

We view ourselves as part of society and rise to the challenges that come along with this. Aurubis makes a decisive contribution to a copper supply that is in line with demand in Europe. Recovering and utilizing non-ferrous metals is the condition for technical progress and a high standard of living. As a central component of innovative technology developments that enhances efficiency, our copper contributes substantially to the energy shift and to improving the CO₂ balance in modern life. The shift towards renewable energies wouldn't be possible without copper.

Copper recycling is an important cornerstone of copper production for Aurubis – especially in a country low in raw materials such as Germany. We use a growing proportion of recycling materials as input for copper

production, which helps to close material cycles in an environmentally sound manner. Non-ferrous metals aren't used up but can be recycled as often as desired.

Resource efficiency is and remains an important issue. We want to utilize what already exists more strongly. For instance, this means drawing even more from increasingly complex raw materials.

As we see it, economic success, the wise use of resources, minimal effects on the environment and responsible conduct with regards to our employees and society form the basis for sustainable economic activity.

This convergence of the economy, the environment and people is reflected in Aurubis' Sustainability Strategy, which enables us to trace our sustainability approach along the value chain of copper in the areas of raw materials, processes and products. With the Sustainability Strategy, we have established the main areas of activity, mid-range goals and action plans for the coming years.

We have therefore set the course for environmental protection in the Group. We are pleased that we were able to improve our environmental performance in the past several years again. However, we want to continue moving forward in the future as well.



Dr. Thomas Bünger:

»Copper isn't actually consumed when it's used. It can be recycled as often as desired. This fulfills the demands of a sustainable society.«

2013 and 2014 were influenced by considerable challenges, meaningful projects and several instances of progress. The large-scale shutdown in concentrate processing in Hamburg was successfully completed and significant facilities, such as the anode slime treatment plant, were commissioned. With the festive inauguration of the water treatment plant in Pirdop, we finished another large project to expand capacities and improve environmental protection in 2014. A total of 60 % of the capital expenditure volume for the "Aurubis Bulgaria 2014" program was allocated to environmental protection measures.

Regulatory developments, for example the tightening of environmental protection requirements, adjustments to emissions trading or changes in the compensation regulations in the German Renewable Energies Act, have far-reaching effects for our industry. Copper is an exchange-traded metal, so we can't simply pass on additional costs resulting from national or international legislation to customers. This influences our competitiveness. At the same time, additional efforts with respect to productivity and efficiency enhancements are increasingly reaching the limits of technical possibility. Nevertheless: even though comparably low levels of improvement are achieved with equally high capital expenditure these days, we don't rest but continue striving to improve our performance.

We have also actively sought out discussions with our stakeholders during the past two years. Open dialogue is important to us – it allows us to create trust, learn about the views of "the other side" and develop courses of action and solutions together. In addition to responsibility in the supply chain, the topics of resource protection, recycling and energy have also been of great interest. We would like to continue this valuable dialogue in the future as well.

We cordially invite you to take a glimpse into our environmental performance at all of the sites and hope you enjoy reading the report.

Best regards,

Dr. Thomas Bünger

Chief Representative Primary Copper

Company portrait and business model

Aurubis is a leading integrated copper group and the world's largest copper recycler. We produce more than 1.1 million t of copper cathodes each year and from them a variety of copper products. Production expertise is our strength and the driving force of our success.

The Aurubis Group

Aurubis is one of the world's leading integrated copper groups with key expertise in copper production, metal recycling and copper product fabrication. The production of precious metals and specialty products completes our range of services. Aurubis is therefore represented in the main segments of the copper value chain.

Aurubis has production sites in Europe and the US as well as an extensive service and sales system for copper products in Europe, Asia and North America. The largest production centers are in Germany, Belgium and Bulgaria.

The Aurubis Group is managed centrally from the corporate and administrative headquarters in Hamburg, where key production facilities are also concentrated. A total of 6,503 employees worked for the Aurubis Group worldwide as of September 30, 2014. Of this number, 57% worked at the German plants and 43% worked in other countries.

Thanks to our wide range of services, we rank among the global leaders in our industry. Our core business is the production of marketable copper cathodes from copper concentrates, copper scrap and other recycling raw materials. They are processed within the Group into continuous cast wire rod, shapes, rolled products and strip as well as specialty wire and profiles made of copper and copper alloys. Precious metals, other metals and a number of other products, such as sulfuric acid and iron silicate, round off our product portfolio.

Customers of Aurubis include companies in the copper semis industry, the electrical engineering, electronics and chemical industries as well as suppliers of the renewable energies, construction and automotive sectors.

Aurubis is oriented towards sustainable growth and increasing value: the main focuses of the corporate strategy are on expanding our leading market position as an integrated copper producer, utilizing growth opportunities and acting responsibly towards people, resources and the environment.

Aurubis AG was founded in Hamburg in 1866 under the name Norddeutsche Affinerie AG. Following various changes in the ownership structure, an IPO was carried out in 1998. The company was renamed Aurubis as a result of a resolution passed at the company's Annual General Meeting on February 26, 2009. Aurubis shares are part of the Prime Standard Segment of the Deutsche Börse and are listed on the MDAX and the Global Challenges Index (GCX).

		2012/13	2013/14
LME settlement copper price (avg.)	US\$/t	7,513	6,996
Revenues	€m	12,346	11,335
Operating earnings before taxes (EBT)	€m	114	138
Operating net consolidated income	€m	94	99
Capital expenditure	€m	185	134
Personnel expenses	€m	429	425

Business model and corporate structure

Copper production, recycling and processing are closely linked in the Aurubis Group's business model. Aurubis therefore has high potential for efficiency and flexibility in managing raw material procurement, production and sales and has a strong market orientation.

The main input material for copper production is copper concentrates, which are extracted from ores in countries outside of Europe in particular and then purchased. The second raw material base is made up of intermediate products from other smelters as well as copper scrap and other recycling materials, most of which are sourced in Europe. Special processing methods are used for metal production residues, precious metal-bearing raw materials and electronic scrap.

Aurubis' product portfolio includes standard and specialty products made of copper and copper alloys as well as other metals. The annual output of copper cathodes in

the Group is over 1.1 million t, making Aurubis one of the largest producers of refined copper worldwide. Copper cathodes from Aurubis bear a registered trademark on the London Metal Exchange and can be marketed there or sold to trade and industry. Most of them are used in the Group as the starting product for fabricating copper products, so Aurubis guarantees its customers a high level of delivery security.

From an organizational perspective, the business areas are divided into three Business Units (BUs): BU Primary Copper, BU Recycling/Precious Metals and BU Copper Products.

Organizational structure

Corporate functions					
»Energy Affairs »Finance »Research & Development »Human Resources »IT »Investor Relations »Communications »Legal Affairs/Corporate Governance »Risk Management »Environmental Protection »Central Procurement and Logistics »Development »Public Affairs »Health and Safety etc.					
Business Units					
PRIMARY COPPER This Business Unit mainly unites the activities concerned with the production of quality copper in the form of marketable copper cathodes from the primary raw material, copper concentrates. It also produces sulfuric acid. Main sites Hamburg (DE) Olen (BE) Pirdop (BG) Main activities Processing copper concentrates; producing cathodes, sulfuric acid, iron silicate, other specialty products		RECYCLING/PRECIOUS METALS This Business Unit produces copper cathodes from a wide variety of recycling raw materials. It also produces precious metals and other by-products. Main sites Hamburg (DE) Lünen (DE) Main activities Recycling; producing cathodes, precious metals, other specialty products		COPPER PRODUCTS This Business Unit processes cathodes into copper products and markets them. End users include companies in the electrical engineering, automotive engineering and mechanical engineering sectors, telecommunications and construction. Main sites Avellino (IT), Buffalo (USA), Emmerich (DE), Hamburg (DE), Olen (BE), Pori (FI), Stolberg (DE), Zutphen (NL) Main activities Continuous cast rod, continuous cast shapes, strip/foil, shaped wire, specialty profiles	
Revenues, €m	7,709	Revenues, €m	4,058	Revenues, €m	8,622
EBIT (operating), €m	141	EBIT (operating), €m	15	EBIT (operating), €m	31
ROCE (operating)	20.0	ROCE (operating)	5.4	ROCE (operating)	5.5
Employees, avg.	2,114	Employees, avg.	1,460	Employees, avg.	2,759

Copper – a sought-after metal

Global demand for copper is increasing steadily: in 1980 only about 9 million t of copper were manufactured, while the quantity of refined copper produced and processed today is about 21 million t annually. Asia has become the central growth region for copper. With an annual copper demand of about 9.4 million t (2014), China accounts for roughly 44% of total global demand in the meantime. The country's demand continues to grow, leading to expectations of a 25% percent increase to nearly 12 million t of copper by 2020.

In Europe around 3 million t of copper are produced each year, about 17% of global copper output. The volume is tending to stagnate at a high level. The current demand of 3.6 million t corresponds to an annual per capita usage of 6 kg. As the largest copper producer in Europe, Aurubis covers a significant proportion of this demand.

Copper in use

The areas of application for copper are diverse. No metal apart from silver has higher electrical or thermal conductivity. As a result, copper is ideal for use in electrical equipment, electronics and telecommunications. One main application is energy distribution, for which rising levels of copper are required in the scope of expanding renewable energies. The increasing interconnectedness in our offices, growing demands on telecommunications at home and high standards for safety and comfort in today's automotive engineering ensure a constant rise in copper demand. An average of about 25 kg of copper is used in every car – in luxury class models, the amount can be more than twice as high. In addition to its excellent conductivity, "red gold" especially stands out due to its recyclability without a loss of quality.

Copper has an established standing in architecture and construction as well: apart from electric mains made of copper, we can also find copper pipes in water and heat-

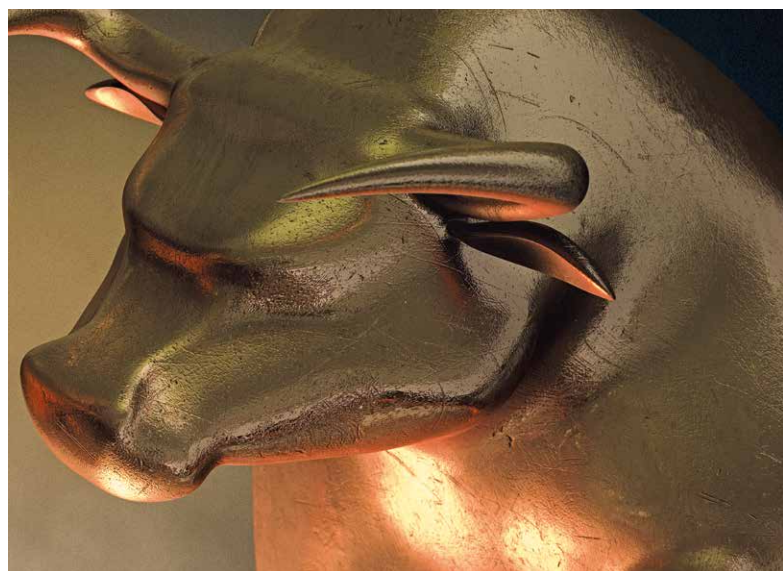

ing systems in our homes. Because of its long lifecycle, corrosion resistance and, not least, its aesthetics, copper is used extensively in roofs and facades. In addition to these classic applications, copper is also increasingly used in many high-tech products, such as lead frames, submarine cable, high-purity copper matrix for superconductors and as copper strip for connectors.

The energy transition requires copper

Copper is a fundamental material for the restructuring towards sustainable energy production as well as the basis for increasing the efficiency of products and applications. Whether 600 km long submarine cable between Germany and Norway for the purpose of exchanging energy between the countries, or in on-shore and off-shore wind turbines – the operation of these facilities would be impossible without large volumes of copper.

Due to its properties, copper is also needed for solar panels as well as in the form of thin-walled copper tubes as heat exchangers for geothermal energy.

Closing the loop – thinking in terms of cycles

Dr. Stefan Boel:

»When Aurubis customers utilize both the product portfolio and the recycling solutions, they have a traceable, complete material cycle and optimally fulfill their process and product responsibility. The loop is closed. Our key expertise and state-of-the-art, innovative processing options in metal recycling create the best conditions for this.«

Executive Board Member for Business Unit Copper Products



With its integrated corporate structure, the Aurubis Group combines the production of copper and other metals with product fabrication. We benefit from this broad position along the value chain, as it offers synergy potential. Product sales and recycling services, the use of site strengths in marketing and material stream management, links between a regional presence and an international orientation – this is the basis for the company's further development.

Our multi-metal recycling ensures that the material cycle for copper and other metals is closed. It is important that products be recycled over and over again at the end of their lifecycles. This ensures that valuable raw materials are used, resources are conserved and environmental impacts are prevented. In accordance with the continuous increase in resource efficiency, we have also set a corresponding goal for ourselves within the framework of our Sustainability Strategy. In the medium term we want to introduce a “closed loop” system with five of our customers.

Aurubis' customers are generally companies in the processing industry. When copper is processed to fabricate final products, production waste and residues accumulate. This includes materials with very high copper contents, such as turnings and millings. Residue fractions, such as slags and industrial residues, result from other processing methods. Aurubis offers its customers collection options for most production residues and wastes and guarantees professional, environmentally sound recycling conforming to the highest standards.

Aurubis is in a position to reintroduce a large variety of metallic scrap to the material cycle. In this way, Aurubis customers can obtain the copper again within a short time and use it in their own production.

Copper – the material of modern life

Everywhere and irreplaceable: copper from Aurubis

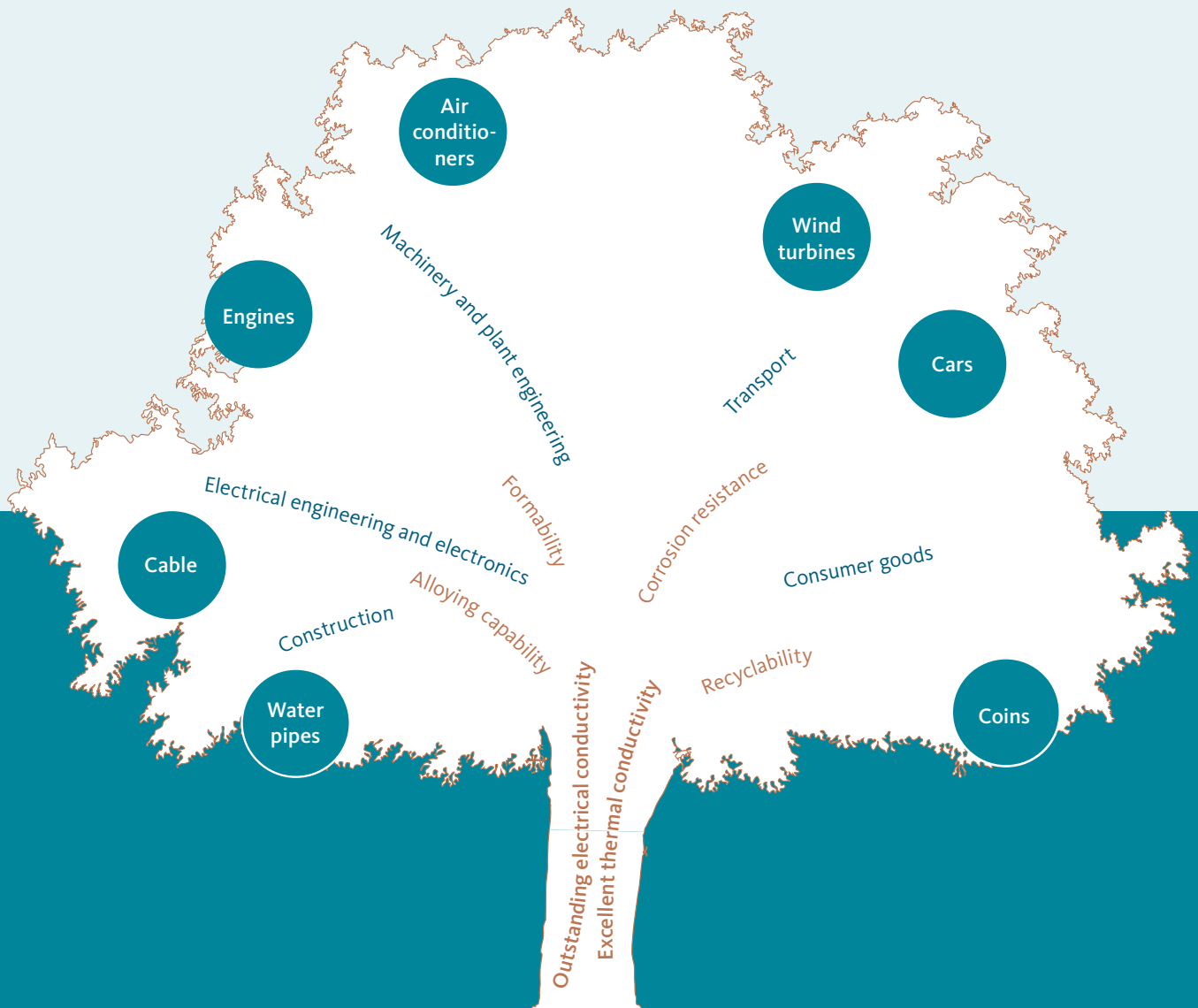
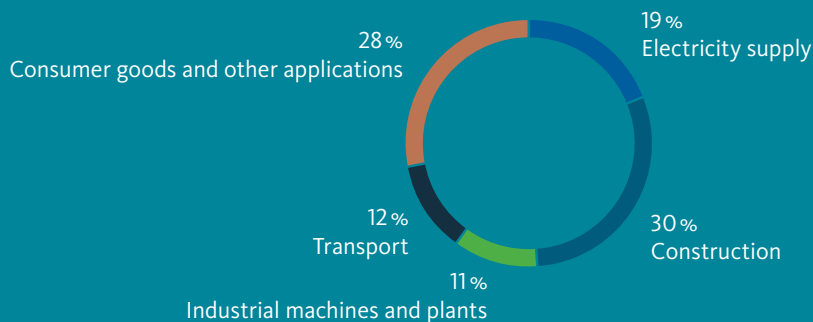

Fig. 1: Global copper demand by industries

for 2013



Climate protection in practice

The role of copper in house construction

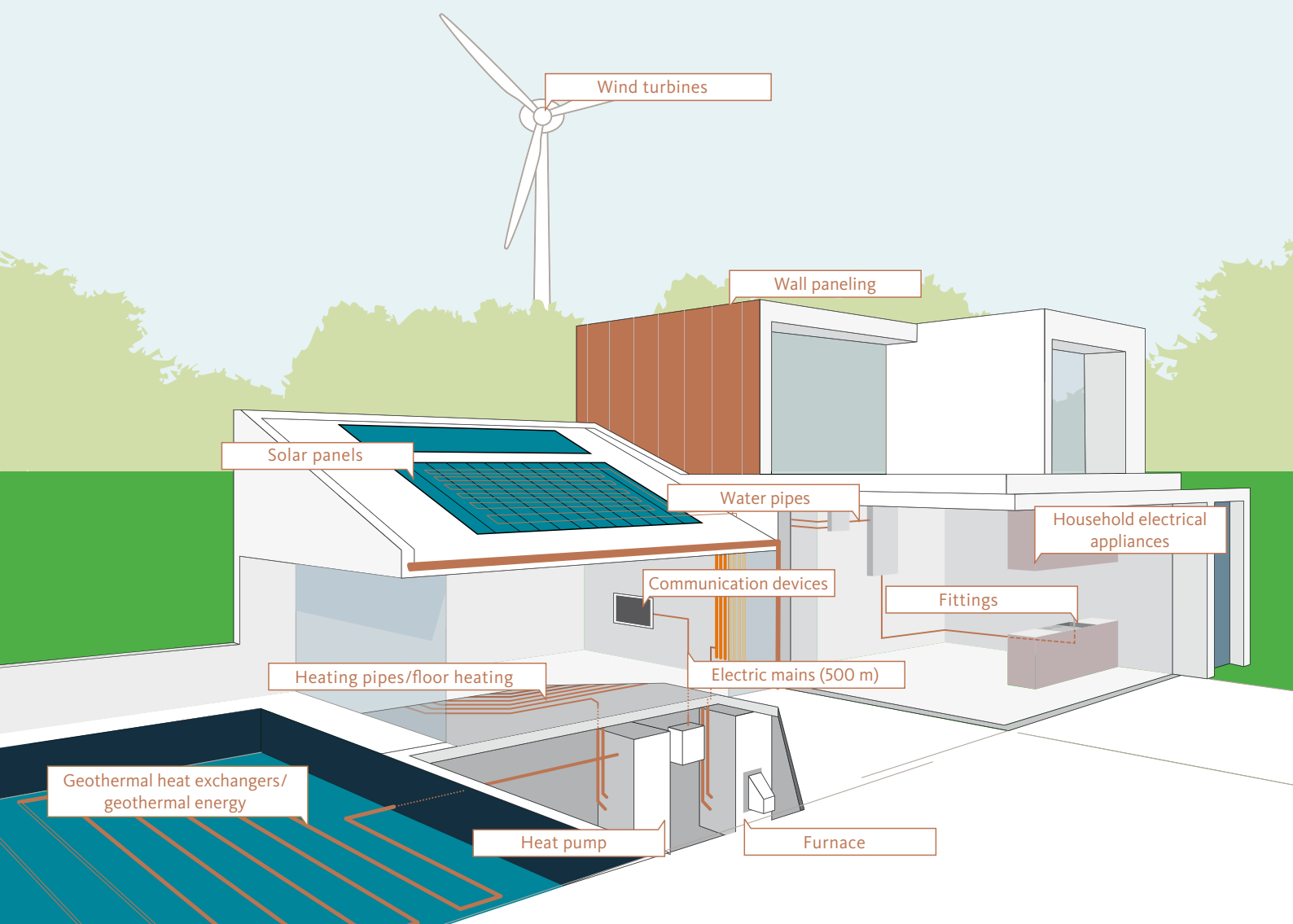

Non-ferrous metals are required for technical progress and a high standard of living. As a central component of innovative technological developments, our high-quality copper provides a crucial contribution to modern life and to the energy shift: without copper, there would be no technologies for renewable energies or continuous efficiency enhancements in this area – and thus no improvements in the CO₂ balance.

Corporate environmental protection principles

To ensure that our environmental protection standards are safeguarded and continuously optimized, the following principles have been established in our corporate guidelines:

- » The continuous improvement of water conservation, soil conservation and immission control is a key aim of environmental protection.
- » For reasons of accountability, environmental and climate protection should be developed in such a way as to preserve natural resources and avoid or minimize strains on the environment and our employees.
- » Issues of environmental protection should be taken into account equally in the planning and development of new products and production processes.
- » Processed raw materials and intermediate products should be brought into the economic cycle as completely as possible and unavoidable waste should be properly recycled or harmlessly disposed of. Raw material suppliers are advised on issues related to environmental protection if needed.
- » Essential precautions to avoid accidents and operational disruptions are in place to prevent or minimize environmental hazards for our employees and neighbors as well as effects on the environment.
- » Our employees' sense of responsibility in environmental protection should be strengthened and an objective, open and respectful dialogue should take place with them, the relevant authorities and the public.
- » Our customers are appropriately informed about the features of our products and necessary safety measures and are advised on questions related to product disposal.
- » External companies working for us must be selected, informed and advised in such a way as to ensure that laws and our environmental protection standards are observed.

Environmental protection in the Aurubis Group



Dr. Karin Hinrichs-Petersen:

»We secure our leading position in environmental protection by learning and improving continuously. We assume responsibility for environmentally sound production across the Group, safeguarding our sites and creating a basis for sustainable growth processes.«

Head of Corporate Environmental Protection

Strategy and targets

Environmental protection, resource efficiency and climate protection have been components of Aurubis' corporate culture for many years. They are among the key topics of the corporate strategy and are established in our corporate guidelines. Our motto: copper is made by people for people.

At Aurubis, production processes utilize state-of-the-art, energy-efficient plant technologies with very high environmental standards in order to conserve natural resources and to maintain a clean environment for future generations. We pursue this standard for all production sites in the Group and across all business processes. We are developing innovative and energy-efficient plant technologies in environmental protection that set new benchmarks worldwide and form the basis for establishing best available techniques (BAT) at the European

level. We keep the effects on the resources water, air and soil to a minimum as a result. In the spirit of resource protection, nearly all of the raw materials are processed into marketable products and waste is effectively avoided and recycled if possible.

Environmentally friendly copper production from primary raw materials such as ore concentrates and multi-metal recycling create the foundation for a responsible and demand-oriented copper supply in Europe. Metals are necessary for technical progress and a high standard of living. Rising demand worldwide is met with limited resources, however. Metal recycling is therefore an important source of raw materials – especially for a country like Germany that lacks natural resources. It makes an important contribution to supply security, sustainability and resource protection.

Our strategy and our targets are established in the environmental protection principles and our corporate policy and are binding across the Group. They define areas of activity and responsibilities, provide a framework for information and reporting, establish the tasks of Corporate Environmental Protection and outline the cooperation with the local Environmental Officers and the Managing Directors/Plant Managers. This ensures uniform procedures for environmental protection within the Group and in our public image. The sites are supported by the Group headquarters with know-how and technology transfer.

We have defined group-wide targets in environmental protection as well as concrete targets for the individual sites (see below and in the Site Reports starting on page 38). We added the topic of soil protection as a group-wide aspect during the reporting period after the EU Industrial Emissions Directive entered into force and resulted in changes to soil protection requirements.

The effectiveness of the targets and measures is reviewed continuously. Environmental Management Systems (especially pursuant to ISO 14001 but also to EMAS at Aurubis Hamburg, Aurubis Lünen and Schwermetall

Halbzeugwerk, Stolberg) support their implementation. Targets are recorded, deviations are evaluated and corrective measures are introduced and tracked for their effectiveness.

Furthermore, energy management systems in accordance with ISO 50001 have been implemented and certified at several sites. An annual external inspection provides us with the opportunity to have our successful environmental protection confirmed by an independent third party and to recognize additional improvement potential.

Fig. 2: Group environmental protection targets until 2015

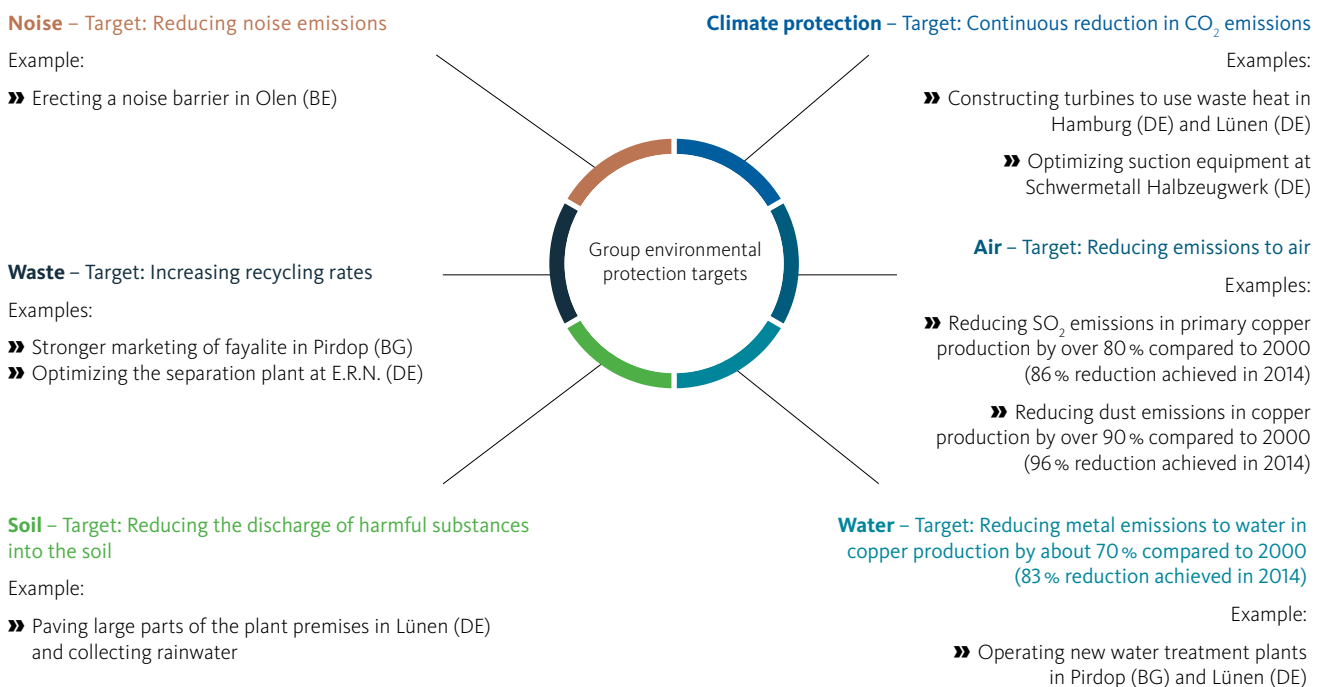

Environmental protection successes

On average, about one-third of total capital expenditure in the Aurubis Group has been used for environmental protection. Because of this and the operation of state-of-the-art, innovative plant technologies, Aurubis has a leading global position in climate and environmental protection in primary and secondary copper production as well as processing copper into products such as rolled sheets, rod and cast products.

As an energy-intensive company, Aurubis feels especially committed to climate protection. We therefore invest in energy-efficient plant technologies, individual measures to save additional energy and volunteer projects like the city of Hamburg's climate protection program at all sites. This long-term involvement has been successful: we have significantly reduced our specific CO₂ emissions at all sites (see Fig. 4, p. 16).

The following measures have significantly contributed to further improvements in environmental protection:

- » Several projects are currently being implemented to continue reducing CO₂ emissions. For example, a turbine was commissioned at the Hamburg plant to produce electricity from waste heat in primary copper production. This project alone will sustainably reduce CO₂ emissions by 5,000 t per year (see p. 40).
- » A wastewater/process water concept based on rainwater retention was developed at the Lünen site to optimize wastewater streams. A rainwater retention facility was commissioned in spring 2014 for this purpose. The collected water is already being utilized as process water. Furthermore, analyses are being carried out to find additional ways to use the water in different processes at the site (see p. 44).

- » At the Hamburg site the voluntary agreement with the city of Hamburg to continue reducing emissions was further implemented in cooperation with the Hamburg Authority for Urban Planning and the Environment.

- » A wastewater treatment plant was constructed at the site in Pirdop, Bulgaria to increase the water quality by reducing emissions to water. The construction of the facility began in July 2013 and it was commissioned in November 2014. With a capacity of 250 m³/h and several retention basins with a volume of 32,000 m³, the plant treats the site's surface water in particular (see p. 31 and p. 42).

- » The collection and cleaning of fugitive emissions in the smelting facilities was improved further as part of the investment project "Aurubis Bulgaria 2014" (see p. 31 and p. 42).

We engage in an open dialogue with the authorities and local citizens across the Group and are involved in a number of projects (see pp. 32-33).

In Hamburg we have been a member of an environmental partnership since 2003 and take part in the Partnership for Air Quality and Low-emission Mobility, which is coordinated by the city of Hamburg. The objective of the partnership is to reduce nitrogen dioxide emissions, which are caused by traffic in particular. Ideas on the topics of employee mobility and efficient carpooling will be developed jointly.



»We view environmental protection as a shared responsibility and utilize our network within the Aurubis Group to identify additional parameters and generate optimizations for the entire Group.«

Georgi Nikolov, General Secretary, Pirdop; Dr. Günther Leuprecht, Production Manager for the Tankhouse and Chemical Plants, Hamburg; Dr. Andreas Specht, Technical Project Management, Hamburg; Paul Bodekor, Manager Safety & Environment, Buffalo; Dr. Hanno Hintze, Acid Plant Manager, Hamburg; Dr. Christian Plitzko, Head of Recycling/Precious Metals, Hamburg; Christiane Henke, Environmental Protection, currently discharged Works Council member, Hamburg; Angel Kostov, Head of Environmental Protection and Occupational Health and Safety, Pirdop; André Weishaupt, Environmental Protection, Hamburg; Filip Lecomte, Head of Environmental Protection and Plant Security, Olen (from l. to r.)

As part of the Hamburg climate protection concept, Aurubis is also participating in the voluntary commitment to ongoing CO₂ reduction, which was agreed on between Hamburg companies and the Hamburg Senate for a second phase from 2013 to 2018. Aurubis has therefore committed to reducing an additional 12,000 t of CO₂ per year.

Striving for energy efficiency, resource efficiency and environmental protection can lead to conflicting goals, however. For example, processing complex recycling materials is very resource-efficient but generally requires high energy consumption. We consistently work on developing our environmental and climate protection activities in order to reduce our environmental effects to a minimum.

The best company environmental protection can only reach the highest level of success with the dedication of motivated employees. Because of this, the involvement and training of our employees is especially important to us. We conduct a dialogue with the public while simultaneously training our employees and sensitizing them to holistic environmental protection with training sessions and action days, for example relating to topics such as environmentally friendly employee mobility and efficient carpooling in May 2013, the Energy Day in Hamburg in July 2014 and the event “Resource Protection and Environmentally Sound Recycling Management” in October 2014. Competitions (e.g. at Aurubis Bulgaria as part of the Green Project) and partnerships also allow employees to actively contribute to environmental protection.

Challenges in corporate environmental protection

The new industrial emissions directive sets new benchmarks and standards for industrial plants in Europe, posing significant challenges for industry. New limit values are defined for air and water on the European level, are transferred to national legislation and must be in place for all facilities four years after they are released at the latest. Aurubis is well prepared in this respect, as our facilities employ the best available techniques (BAT). Nevertheless, new requirements are a challenge in a company that is oriented to growth and enhancing efficiency. Harmonizing environmental protection requirements at a very high level can be cost-intensive and requires strategic planning for environmental investments.

Aurubis is also involved in European projects. For example, we are participating in the three-year test and development phase of the European Commission's Product Environmental Footprint (PEF) and Organizational Environmental Footprint (OEF) together with the overarching European association Eurometaux and the European Copper Institute (ECI). Lifecycle analyses of Aurubis' copper production were carried out for this purpose. The objective of this collaboration is to develop and test the methods for determining the environmental footprint. On this basis the European Commission would like to develop a uniform way to evaluate the environmental performance of products and sectors and create a single market for "environmentally friendly products" and "environmentally friendly organizations (see p. 22). The requirements for sustainable environmental protection are significantly more complex now. Reducing emissions to air, water and soil still forms the basis. However, rising pressure due to the global consumption of limited resources and new developments such as the "circular economy" at the European level is becoming increasingly important. In the future, resources shouldn't be consumed but instead recycled and reused without a loss of quality.

Aurubis has the ideal conditions to provide solutions to these new challenges. One significant element for environmentally friendly production in the Aurubis Group is the efficient use and processing of complex metallic raw materials, following a multi-metal approach that converts as many elements found in the raw materials as possible into marketable products.

Today, Aurubis sources raw materials worldwide from more than 50 countries, with a focus on Europe for secondary raw materials. A number of recycling raw materials, such as PCBs, copper tubes and electronic scrap, are purchased and processed as part of Aurubis' multi-metal recycling. Aurubis also provides solutions for closed cycles along the value chain (see p. 7 and p. 24).

We will continue to address the topic of resource efficiency as well. In order to exhibit successes in this area, indicators should be developed that enable improvements in resource efficiency to be managed. It is crucial that they be established in a way that strengthens environmentally sound copper production and multi-metal recycling in Europe.

Environmental protection – facts and figures

Fig. 3: Capital expenditure for environmental protection measures

in € million in Aurubis Group copper production

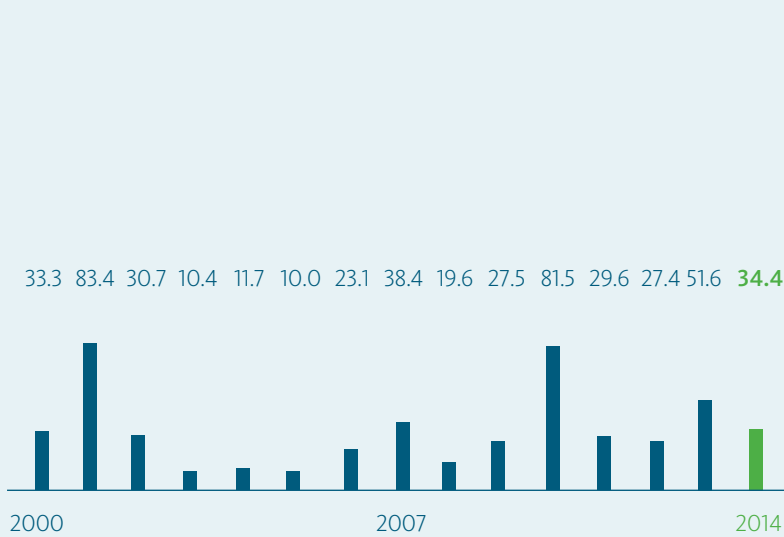

A long-term average of about one-third of total capital expenditure has been applied to environmental protection measures. Total capital expenditure for environmental protection in copper production since 2000 has amounted to € 500 million. By implementing these measures and operating state-of-the-art, innovative plant technologies, Aurubis holds a leading position in climate and environmental protection in primary and secondary copper production.

Today, continued high capital expenditure for environmental protection leads to relatively small improvements, as a leading global environmental standard has already been achieved and there are technological boundaries in some instances, as in the case of emission reduction.

Fig. 4: Fuel-related CO₂ emissions from Aurubis Group copper production

CO₂ emissions in t/t of copper output



At 0.20 t of CO₂ per ton of copper output, specific emissions from fuels in copper production are at a low level. Product-related emissions have even been reduced by 36% since 2000.

Fig. 5: Dust emissions from copper production successfully reduced in the Aurubis Group

Dust emissions in g/t of copper output

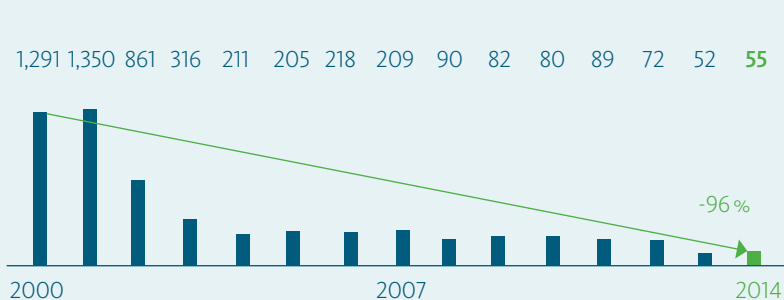

Specific dust emissions in primary and secondary copper production have been reduced by 96% since 2000.

Fig. 6: Highest environmental standards worldwide

SO₂-Emission from copper smelters in kg SO₂/t of copper output

- International copper smelters (avg.): 174 kg SO₂/t Cu
- European copper smelters (avg.): 42 kg SO₂/t Cu

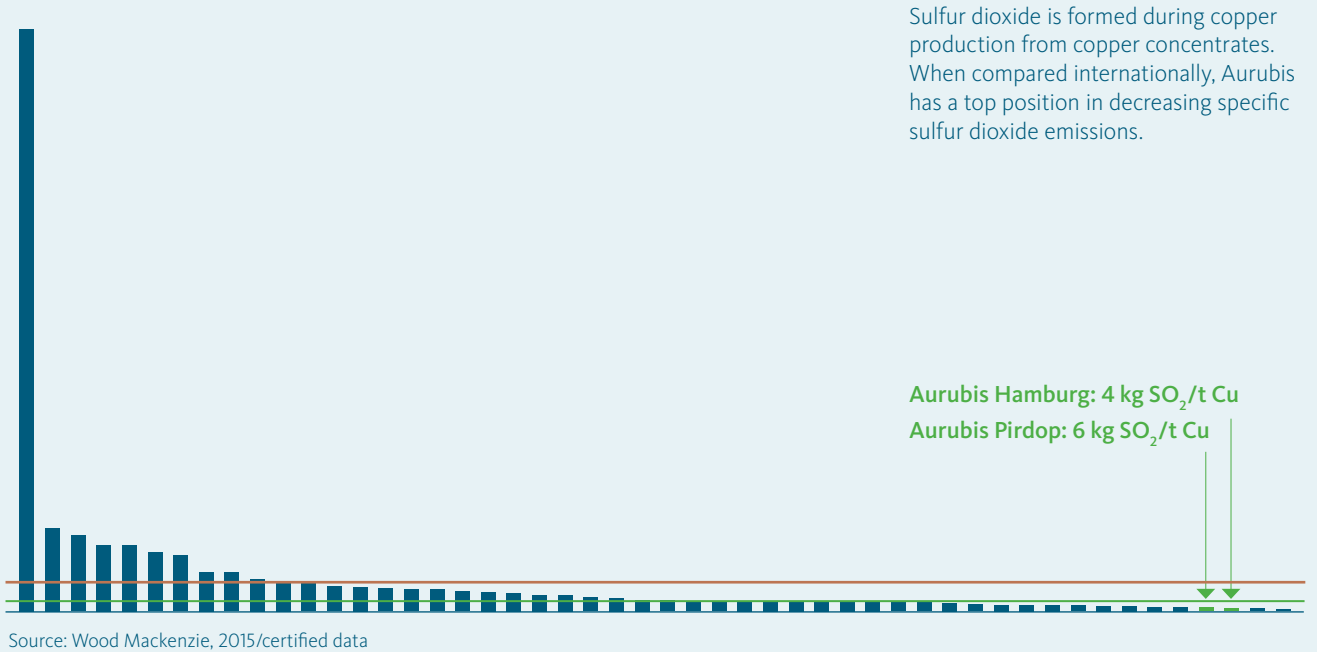
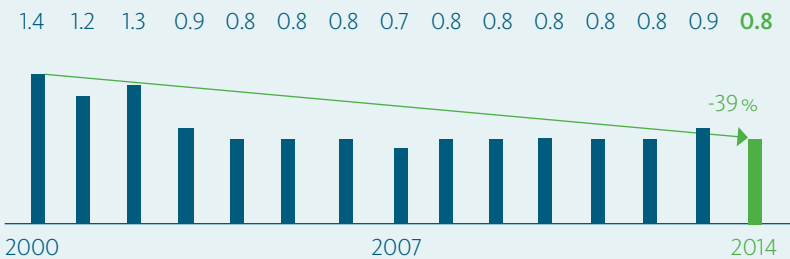

Fig. 7: Potable water consumption in Aurubis Group copper production

Potable water consumption in m³/t of copper output



Aurubis uses river water wherever possible to conserve the natural potable water resources. Aurubis has reduced its specific potable water consumption in copper production by 39% since 2000. In addition to increases in the facilities' efficiency, the use of rainwater was a primary reason for this.

Fig. 8: Metal emissions in water from Aurubis Group copper production

Metal emissions in water in g/t of copper output

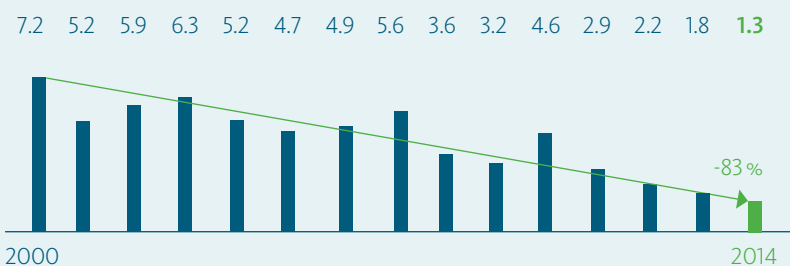

Apart from the reduction in emissions to air, we have also made significant improvements in water conservation: we have decreased metal emissions to water in copper production from 7.2 to 1.8 g per t since 2000, a roughly 83% reduction. We therefore achieved the environmental protection target of reducing emissions to water by about 70% by 2015 during this reporting period. Our goal is now to maintain this low level in the future as well.

Sustainability as part of the corporate strategy

Sustainable conduct and economic activities are among the central components of Aurubis' company strategy

For Aurubis, acting responsibly means having a conscientious attitude towards the environment and limited natural resources. However, it also includes responsible interactions with employees, suppliers, customers, neighbors and the plant areas and communities where Aurubis is active.

In addition to responsibility as a contribution to sustainable conduct and economic activity, the Group's five corporate values also include performance, integrity, mutability and appreciation (the first letters of which spell the German word "PRIMA", meaning "great"). Legal regulations, the PRIMA corporate values and internal policies and management systems form the basis for responsible corporate governance.

Aurubis respects human rights and advocates for their protection. Adherence to the internationally recognized core labor standards of the International Labour Organization (ILO) is of central importance. Aurubis joined the United Nations Global Compact in December 2014 and thus commits to working toward the implementation of its ten principles.

Sustainability as part of the corporate culture

A key topic in the Group is the further integration of sustainability in the corporate culture. Aurubis has already achieved a great deal in this area at all of the Group sites as well as across all of the business processes. We contribute to minimizing possible effects of our business activities on the environment, employees and society from the start with various measures.

In order to pursue this sustainability approach more systematically, Aurubis developed and presented a comprehensive Sustainability Strategy in fiscal year 2012/13. The strategy approach addresses the three components of economic, ecological and social sustainability, or the



Kirsten Kück:

»Sustainability isn't just a trend for us but a key element of the corporate strategy. Responsible business practices are the foundation for operative business and, together with healthy growth, form the basis for sustainable economic success and a secure future for the company.«

Sustainability Manager

classic convergence of the economy, the environment and people. We view these factors in the context of the individual phases of raw materials, processes and products. The Sustainability Strategy includes the main areas of activity for the coming years. Targets and action plans have been developed based on these areas.

For example, Aurubis will generate and implement additional ideas from Innovation Management, continue reducing emissions, expand the recycling of complex recycling materials further, enhance occupational safety, address supply chain responsibility more intensively and develop the dialogue with interest groups.

The rise in questions and requirements from different interest groups validates us in this approach. For instance, customers increasingly value environmentally friendly products, modern production processes and a secure and responsible raw material supply. Expectations regarding resource efficiency, environmentally sound recycling and multi-metal recycling solutions are rising.

The Aurubis Sustainability Strategy

The overarching Aurubis Sustainability Strategy addresses the convergence of “Economy-Environment- People” among the individual phases of the Aurubis value chain, “Raw materials-Processes-Products”. Eight central action areas were identified and targets were developed accordingly.

PEOPLE

ECONOMY

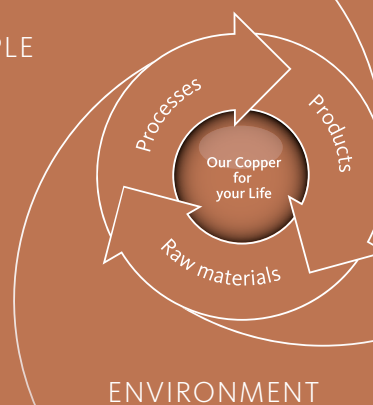

Sustainability Management coordinates the Sustainability Strategy process and reports to the responsible Executive Board member.

Comprehensive sustainability reporting

In 2014 the fourth edition of the group-wide Aurubis Sustainability Report was released featuring the Group’s sustainability achievements in fiscal years 2011/12 and 2012/13. Like the previous three editions, the latest

Sustainability Report is aligned with the guidelines of the Global Reporting Initiative (GRI). This orientation to the internationally recognized reporting standard (Version GRI G 3.1) makes the company’s sustainability reporting more transparent and easier to compare. In addition to highlighting relevant key figures, the report outlines targets and challenges and presents the Aurubis Sustainability Strategy. The Aurubis Sustainability Report is available at www.aurubis.com/en/responsibility/sustainability.

Targets and measures in the Aurubis Sustainability Strategy

Action fields	Targets and measures ¹	Date
ECONOMY		
Economic stability	» Achieve a return on capital employed (ROCE) of at least 15 %	2018
Innovation	» Increase efficiency of copper in products by 15 %	2018
	» Conduct 15 projects with original equipment manufacturers (OEMs) on new applications of copper	2018
	» Generate and implement 18 developed ideas from Innovation Management	2018
ENVIRONMENT		
Resource efficiency and recycling	» Increase the quantity of processed complex recycling materials (e.g. electronic scrap) by 20 %	2018
	» Audit and certify Aurubis pursuant to the WEEE End Processor Standard (WEEE: Waste Electrical and Electronic Equipment)	2016
	» Establish a “closed loop” approach with a minimum of five customers	2018
Energy	» Reduce CO ₂ emissions by 100,000 t through energy efficiency projects and internal electricity production	2018
Water and air ²	» Reduce metal emissions to water by 10 %	2018
	» Reduce dust emissions to air by 10 %	2018
	» Reduce SO ₂ emissions in primary copper production by over 80 % compared to 2000	2015
PEOPLE		
Occupational safety and health protection	» Reduce work-related accidents with lost time (LTIFR) to 4.3	2018
	» Introduce measures to make working times more flexible with respect to different life phases	2018
Training and education	» Develop measures to increase interest among girls and women for technical education and professions	2018
Responsibility in the supply chain	» Set up and expand systematic supplier screening	2016

¹ The base fiscal year is 2012/13 if not otherwise stated ² Base year: 2012

Energy efficiency and energy management

A leader in energy efficiency

The efficient use of energy is not only an ecological responsibility for Aurubis but an economic one as well. All of the sites strive to use energy as sparingly as possible. Aurubis is a leader in energy efficiency when compared internationally.

Fig. 9: Energy efficiency in the copper industry

in GJ/t cathode in 2010

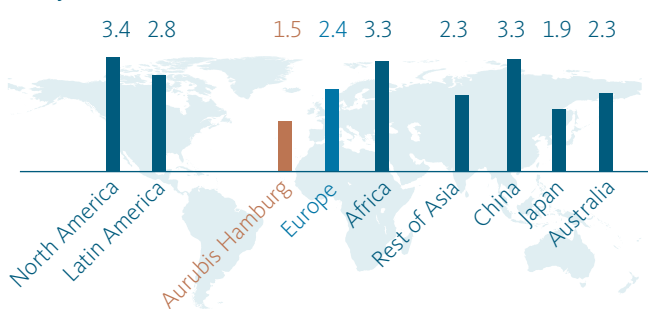

Source: Brook Hunt, a Wood Mackenzie Company Copper Refinery Cost Service – Summary and Analysis – February 2012

As an energy-intensive company, Aurubis faces the challenge of ensuring that the necessary energy is reliably available according to the site-specific requirements and at competitive prices. Since copper is a product priced on the exchanges, additional local costs can't be passed on to customers. In order to optimally manage energy consumption and to identify optimization potential, extensive energy management systems were developed at the sites, which – where it makes sense – are successively being certified in accordance with the internationally recognized standard ISO 50001. The Energy Affairs Department coordinates all of the activities relevant to energy in the Group.

In 2012/13 the bulk of the energy input amounted to about 3,517 TWh; in 2013/14 it was at around the same level at 3,651 TWh. Aurubis has reduced the specific energy input in copper production by 16% since 2000 and was at a very good level during the reporting period as well, at 1.9 MWh per t of copper output (see Fig. 10). The main energy sources are electricity and natural gas.

Individual measures to save energy were implemented in the entire Aurubis Group during the reporting period. For example, all of the sites are working on utilizing accumulated waste heat. As a result, the heat and process steam supply at the Pirdop, Lünen and Hamburg sites is largely covered by waste heat.

Aurubis assumes responsibility for climate protection and strives to keep emissions of climate-damaging greenhouse gases as low as possible at all of the sites. The main source of CO₂ emissions is energy consumption. As a result of continuously optimizing the energy input, CO₂ emissions were reduced further. Direct and most indirect CO₂ emissions in the plants involved in emissions trading amounted to about 1.9 million t of CO₂ in 2014. Specific emissions from fuels in copper production are at a low level of 0.20 t of CO₂ per ton of copper output. Product-related emissions have even been reduced by 36% since 2000 (see Fig. 4, p. 16).

Environmental protection and energy efficiency

One significant challenge for Aurubis is the fact that the continuous efforts to increase efficiency are increasingly reaching the boundaries of technological possibility. A considerable proportion of electricity consumption at Aurubis is already utilized for environmental protection.

The rising use of complex recycling raw materials with comparably low copper content requires a high level of energy relative to the copper output, though additional materials are recovered in addition to copper. When considering the total input of recycling raw materials in the calculation, the primary energy demand is decreasing consistently. For this reason, ongoing efforts will be made to bring environmental protection and resource and energy efficiency in line with one another optimally.

2030 EU energy efficiency target

In October 2014 the European Commission agreed on an energy efficiency target of 27% for 2030, meaning that the primary energy consumption is to be reduced by 27% by 2030 compared to 2005. The target isn't binding at EU or national level. At the same time, emissions of greenhouse gases are to be reduced by 40% and the proportion of renewable energies increased to 27%.

The central instrument in the fight against climate change is emissions trading, whose purpose is to motivate companies to invest in clean technologies. The European Commission has decided to reduce the CO₂ certificates annually by 2.2% instead of the current 1.74% starting in 2021. These regulatory developments have far-reaching effects on industry. The work processes in the basic materials industry include a physically defined quantity of process-dependent raw material or energy emissions that can't be decreased. The artificial tightening and reduction of allocated certificates would result in an increase in prices and therefore economic strains and impacts on competitiveness.

Furthermore, increases in efficiency from the past can't be automatically transferred to comparable possibilities in the future. The more measures that have already been implemented in energy efficiency, the more difficult it

becomes to optimize the energy demand further. Because Aurubis is already a leader in climate and environmental protection and has achieved a leading global environmental standard, and there are technological boundaries to emission reduction, similarly high levels of capital expenditure today lead to low levels of improvement in comparison. Furthermore, the much-discussed flexibilization of power take-up is contrary to the energy-efficient operation of production plants.

The laws of physics and economic conditions must be aligned with one another. Investments in energy efficiency can't only be measured in terms of their amortization period but have to be pushed through in an uncertain environment in the first place. Especially for investments that entail a return time of two or three years, the political and regulatory environment has a very high influence on the willingness to invest.

Ultimately, there is a risk that energy-intensive companies will relocate their production outside of Europe. This wouldn't only remove part of the European value chain and associated investments. More and more energy-intensive basic commodities (such as copper) would be produced outside of an emissions trading system – often connected with higher CO₂ emissions – and possibly exported to Europe for processing only.

Fig. 10: Specific energy consumption in Aurubis Group copper production

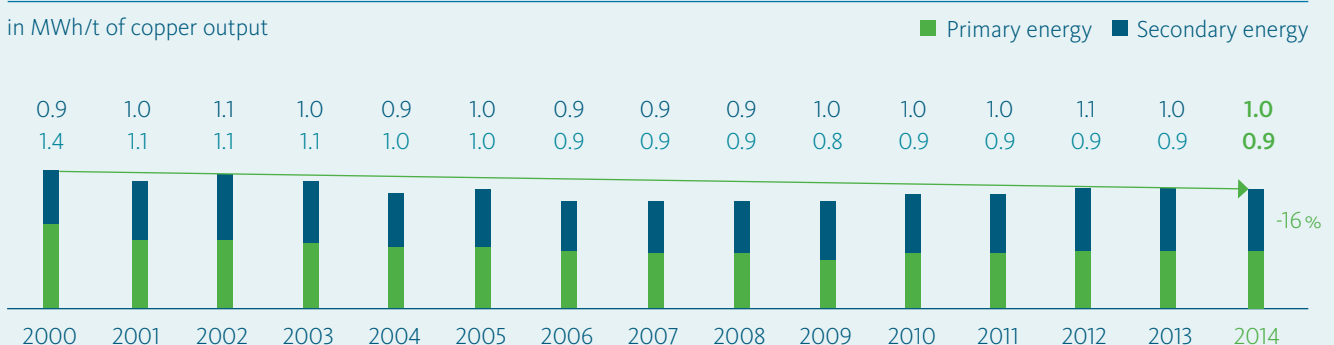

The environmental footprint of products and organizations

Organizational Environmental Footprint (OEF) and Product Environmental Footprint (PEF)

The European Commission would like to create a single market for green products and support environmentally friendly organizations. What makes a product or an organization “environmentally friendly”, and how can this be measured? These questions are answered in so-called lifecycle assessments or eco-balances. However, a variety of methods and approaches are currently used, which often makes a comparison difficult. With the development of the environmental footprint, the European Commission intends to create a uniform method across Europe to determine and evaluate the environmental performance of products and organizations and to enable comparisons.

The method was introduced in 2013. There are two areas that require different approaches: the Product Environmental Footprint (PEF) and the Organizational Environmental Footprint (OEF). For a meaningful assessment, additional rules are necessary that take the special features of different kinds of products or organizations into account. Categories are distinguished for products (Product Environmental Footprint Category Rules, PEFCR), while organizations are broken down by sectors (Organizational Environmental Footprint Sector Rules, OEFSR). These category and sector rules should make it possible to focus on the relevant output indicators and processes of a product group or a specific sector, making assessment results easy to compare.

The European Commission started a three-year pilot phase to test this method and called on interested organizations to participate. During this phase the presented methods will be tested and the rules for the product categories and sectors will be developed at the same time.

Though our production methods are already in line with the highest environmental standards, we want to improve them continuously through increased efficiency and lower emissions. We would also like to make Aurubis' resource conservation measurable; this is why we are involved in the Environmental Footprint project.

Aurubis is involved in both areas. The company is participating in the “Copper Production” project in the OEF pilot phase. This is coordinated by the Joint Research Centre of the European Commission. For the PEF pilot phase, Aurubis and other companies and associations in the non-ferrous metals and steel industries initiated the pilot project “Sheet Metal for Different Uses”. Initially, an Environmental Footprint will be determined in both projects on a trial basis using existing data. The results and experience gained in the process will be used to establish the relevant indicators (e.g. influence on climate change or ozone depletion) and to draft rules for the product category or sector. The next step is to test these rules with data from individual companies in the respective sectors. Aurubis is also involved in this phase and has already offered to provide its own data for these studies. The experience from the entire test phase will ultimately help to adjust the methods so that they deliver meaningful results.

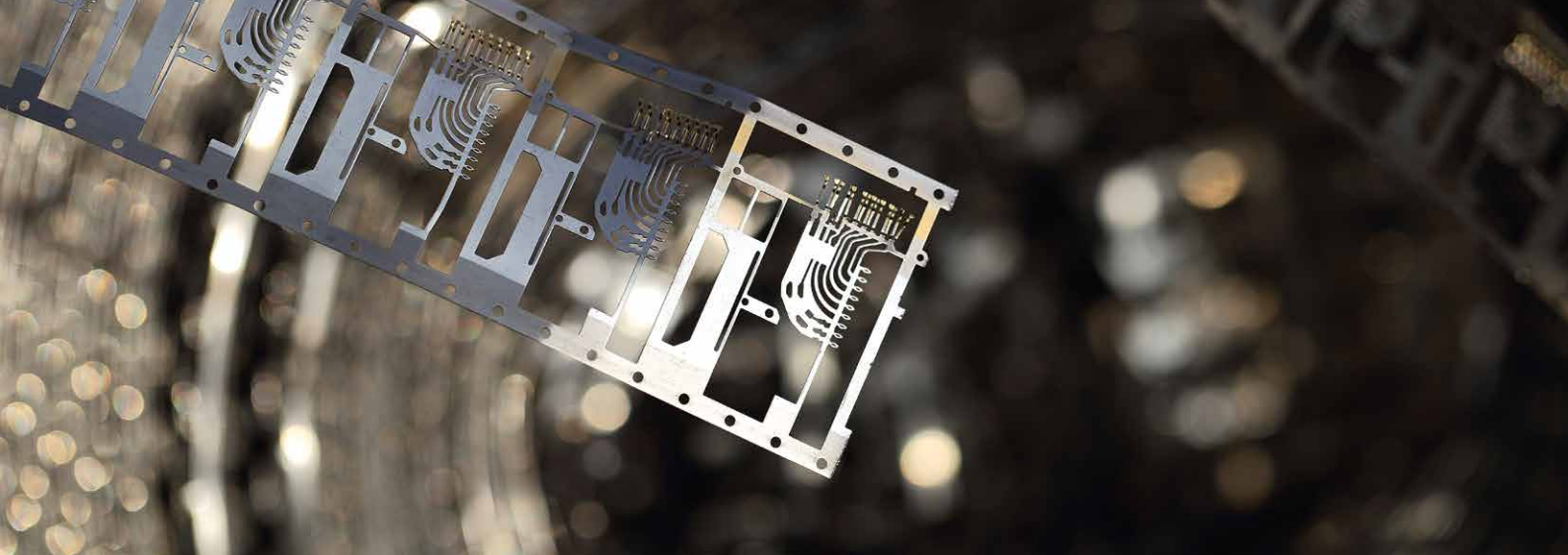
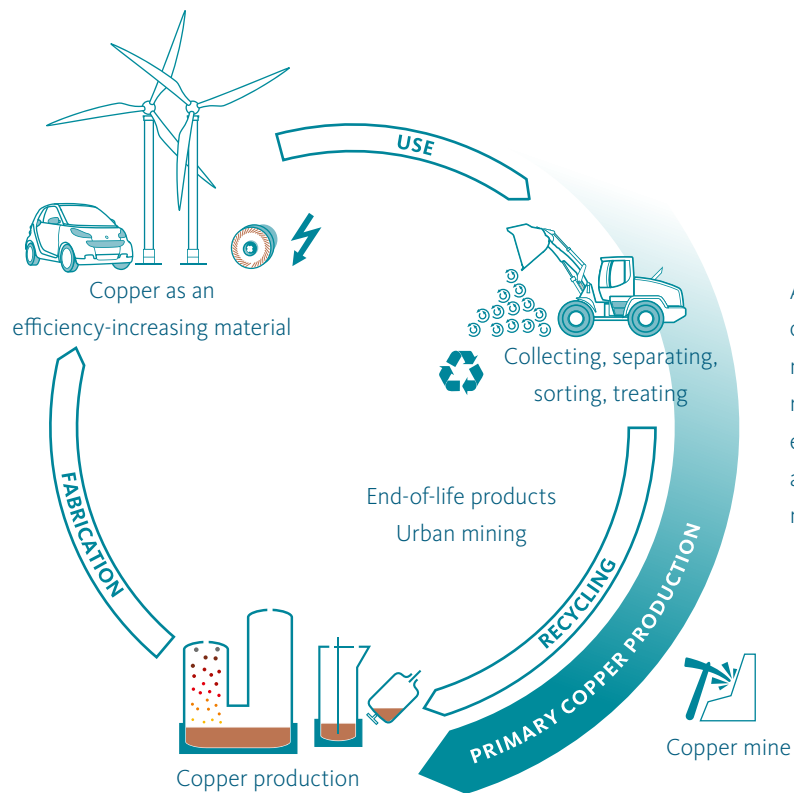

Fig. 11: A valuable cycle

No metal besides silver has higher electrical or thermal conductivity than copper. Copper therefore plays a key role in the switch to sustainable energy production as well as increasing the efficiency of products and applications.



Aurubis processes a number of different recycling raw materials and has environmentally friendly and efficient recycling options as part of the company's multi-metal recycling.

Aurubis works with innovative and energy-efficient plant technologies in environmental protection, which set new benchmarks worldwide. The effects on the resources water, air and soil are kept to a minimum with the use of the best available technologies and high environmental protection standards.

Recycling and resource efficiency

Non-ferrous metals such as copper are not actually consumed when they are used. They go through the material cycle and are predestined to fulfill the requirements of sustainability and resource efficiency. Aurubis already uses a large volume of recycling materials and has set the target of increasing the proportion of complex recycling materials further, by 20 %, from 2013 to 2018.

Copper is a metal that can be recycled as often as desired without a loss of quality. As a result, copper with the highest purity can be produced over and over again from recycling materials.

Shrinking product lifecycles, for example in the case of electrical and electronic devices, lead to a continuously growing supply of recycling raw materials. New technologies and product requirements result in smaller and smaller amounts of recyclable raw materials being used in products. Even marginal quantities of copper and precious metals, for example from electronic scrap, can be almost completely recycled at Aurubis.

Urban mining – cities as aboveground raw material mines

Densely populated cities hide real treasures. While certain waste and scrap has been processed into new metal for a long time, new recycling processes, technical progress and optimized recovery methods open up possibilities to return existing raw materials to the production process. This utilization of freed-up resources and the use of waste and residue streams describe the urban mining model. Some of the world's copper supply is already stored in cities, for example in building structures or in old appliances. In addition to mining from primary sources, copper, other metals and a variety of additional materials can be recovered when buildings are demolished.

This corresponds to our core expertise and our processing options in metal recycling. Aurubis increases the supply of recycling material by returning resources (including those that are difficult to access) to the material cycle with multi-metal recycling. However, it must be kept in mind that recycling alone isn't sufficient to cover the rising copper demand. Production from primary raw materials will also be necessary in the future. Primary copper becomes recycled copper after the first recycling process.

Recycling at Aurubis

Responsible resource use is a matter of course at Aurubis. For example, metals contained in process residues of the non-ferrous metals industry, in waste or in used products become high-quality materials again at Aurubis with the help of state-of-the-art technologies.

In the Group's recycling center in Lünen we use a broad range of complex recycling materials with various qualities and properties, e.g. metal-bearing industrial residues, copper-bearing shredder materials and electrical and electronic scrap. The various recycling materials are processed in the tankhouse into cathode copper, which is no different from copper from primary raw materials in terms of quality and is traded on the exchange.

At Aurubis, recycling follows different procedures according to the raw material composition. This enables an especially wide range of materials to be processed competitively in an environmentally sound manner suited to the material type. In addition to copper, precious metals, nickel, tin, lead and zinc are recovered. The use of increasingly complex raw materials, a constant increase in the quantity of metals recovered, particularly by-metals, and flexible raw material utilization – this is the multi-metal recycling strategy at Aurubis, which combines resource and energy efficiency.



Stefan-Georg Fuchs:

»With our objective of being audited and certified in accordance with the WEEE End Processor Standard by 2015, we are making a decisive contribution to improving recycling management. We can continue increasing the volume of secondary raw materials and thus conserving primary resources with internationally organized recycling and disposal processes and the prevention of illegal scrap imports.«

Executive Director Complex Materials, Business Unit Recycling/Precious Metals

Dr. Thomas Bünger:

»In order to achieve our set target of significantly increasing the amount of processed complex recycling materials by 2018, we are continuously expanding the processing capacities and investing in state-of-the-art facilities for multi-metal recycling. We therefore emphasize our leadership role in copper recycling and, at the same time, make an additional contribution to protecting natural resources.«

Chief Representative Primary Copper



Metal resources stay in the material cycle in WEEE recycling – and the environment wins

The objective of EU directive 2002/96/EC, the Waste Electrical and Electronic Equipment Directive (WEEE for short), is to responsibly handle the growing quantity of electronic scrap from electrical and electronic equipment that is no longer in use.

Keeping e-scrap in the material cycle, e.g. by working against the illegal export of old equipment, supporting research projects in metal recovery and developing treatment standards for secondary raw materials containing copper and precious metals, are just a few of the aspects of WEEE.

A voluntary standard for treating or processing precious metal-bearing WEEE fractions such as printed circuit boards was developed under the EERA (European Electronics Recyclers Association) and Eurometaux and was signed by Aurubis and three additional companies in September 2014. This process was strongly driven by industry. Aurubis will be one of the companies to ratify this technical standard, committing itself to implementing all of the requirements for its e-scrap processing sites and having this audited by an independent consultant.

For the environment:

close cooperation with policymakers, authorities and associations

REACH continues to call for a high level of commitment at Aurubis

The European REACH directive, which has been in effect since 2007, created a new framework for chemicals management. REACH stands for “Registration, Evaluation, Authorization and Restriction of Chemicals”. The objective of the directive is to collect information on all of the materials on the market in the EU, to evaluate them and to protect humans and the environment with appropriate measures. This is initially carried out by the producers and importers of the materials, who compile data, perform analyses if necessary, evaluate the results and make them accessible to the authorities in the form of registration dossiers. Together with other companies, Aurubis became involved in a number of consortia at the European level early on. This ensured that the registration dossiers were scientifically based and developed cost-efficiently at the same time – an approach that proved to be successful.

At Aurubis, the group-wide fulfillment of the REACH requirements is coordinated centrally in Hamburg. Furthermore, we have contacts at the individual sites who are responsible for local implementation. This is very important in an expanding company in order to ensure that all of the requirements are complied with. Most of the materials Aurubis produces and imports were registered successfully and on time in 2010 and 2013. We now regularly review the relevant material streams at the sites and prepare additional registrations that have become necessary. The existing registration dossiers are regularly updated to adjust them to current requirements and proven approaches and to take new results into consideration.



Jan Drzymalla:

»Extensive new insights into the effects of materials on human health and the environment have been gained from the current registrations, but a number of new questions have also been raised. We communicate intensively and constructively with authorities such as the European Chemicals Agency (ECHA), associations and downstream users in order to share experiences and proven strategies and to develop new approaches to challenges.«

Corporate Environmental Coordinator, Hamburg

Another central responsibility is consultation on the safety data sheets in the Aurubis Group. The CLP regulation on the classification and labeling of materials introduced a new classification system, and due to new insights, there are also ongoing changes to the classifications of materials. This has gathered speed due to the information gained within the scope of REACH. The safety data sheets have to be continuously updated accordingly and, in some cases, supplemented with extensive exposure scenarios.



Dr. Jörn Mühlenfeld:

»While the emphasis of REACH was initially on registrations, the focus of the EU authorities is shifting more and more to potential risks. Because of the many risk assessments available, metals quickly fall under regulators' consideration and are often prioritized for further regulations such as restrictions and licensing procedures. However, there are already comprehensive regulations for metals to safeguard the protection of health and the environment. Aurubis works together with associations to ensure that the focus is placed more strongly on risks that actually exist so that new regulations contribute to real improvements in health and environmental protection.«

Corporate Environmental Manager, Hamburg

New EU directives determine future environmental requirements in the Aurubis Group

One example is the Industrial Emissions Directive 2010/75/EU dated November 24, 2010, which forms the foundation for permits for industrial plants in Europe with particular environmental relevance. This directive develops the guiding principle of sustainable production. The objective is to achieve a high level of protection for the environment overall.

To establish the best available techniques (BAT) and new environmental standards, the European Commission

organized an exchange of information among the EU Member States, the relevant industries and environmental associations (Sevilla Process). The BAT reference document for the non-ferrous metals industry will be passed soon. The emission values described in the conclusion must be adhered to after four years according to the Industrial Emissions Directive. Companies therefore have to review whether their existing facilities can adhere to the new emission values for air and water in the future in order to be able to plan measures for additional emissions reductions if necessary. The BAT reference documents include detailed information about the techniques used, their operating conditions and the emission values that can be achieved with them. This makes them very complex. Aurubis has actively helped shape this process; experts from the entire Group from administration and the plants have worked intensively, applying their specialized knowledge.



Daniela Cholakova:

»New requirements, laws and parameters are often established at European level these days. Many of them concern environmental protection. As an employee of Corporate Environmental Protection, I work in Brussels and contribute Aurubis' experiences to the process of developing new regulations.«

Corporate Environmental Manager, Brussels

Environmental protection milestones

at the Pirdop site (1997-2014)



1997–2004

Environmental Remediation Program

The metallurgical plant “Georgi Damyanov” operated as a state-owned company from 1957 to 1997. In this period, the state of Bulgaria made insufficient investments in environmental protection, resulting in significant impacts to the local environment. The plant was privatized in 1997 by the Belgian group Union Minière. The privatization contract included an Environmental Remediation Program with a budget of US\$ 25 million. The program included demolition of abandoned industrial buildings and safe disposal of the generated debris, remediation of waste storage areas (the sludge pond known as “Blue Lagoon”, a fayalite storage area, a slag storage area) and remediation of contaminated soil throughout the plant.



2002

Construction of fayalite landfill

A specialized landfill for fayalite, the waste material from the operation of the flotation plant, was constructed and operated in full compliance with all environmental requirements. The second stage of the landfill was completed in 2008 and the third stage is under construction and is expected to be completed in the first half of 2015.

2005

Opening of wastewater treatment plant

In May 2005 a new wastewater treatment plant (WWTP) started operation. The WWTP employs a modern technology designed by a Canadian company for the treatment of industrial wastewater in a three-step process, which guarantees compliance with the water emission limits.



2004

Belgian Prize for the Environment

Umicore was granted the Belgian Prize for the Environment 2003-2004 in the category “International cooperation for sustainable development” for the successful completion of the Environmental Remediation Program.



2005

Upgrade of the sulfuric acid plant

The gases rich in SO₂ which are formed during the copper concentrate smelting process in the flash smelting furnace and the converter are cleaned, dried, converted into SO₃ and then adsorbed in the sulfuric acid production plant. The plant consists of two identical systems which are fully automated and produce concentrated sulfuric acid, both for external clients and for internal needs.

2004

Construction of the second sludge landfill

The second specialized landfill for calcium arsenate sludges was constructed and operates in full compliance with all environmental requirements, ensuring the highest protection of soil and groundwater.

2005

First IPPC permit issued

In June 2005 Umicore’s environmental protection efforts were recognized with a permit under the European Integrated Pollution Prevention and Control Directive (IPPC) as part of Bulgaria’s accession to the EU. The directive comprises the integrated avoidance and reduction of environmental pollution in specific industrial activities.

2006

ISO 14001 certification of the Environmental Management System

In March 2006 the Pirdop site’s Environmental Management System was successfully certified in accordance with the ISO 14001 standard by an external auditor for the first time.





2008

Construction of secondary gas cleaning system

The secondary gas cleaning system employs the best available techniques (BAT) for emissions control of gases from copper smelters. Its operation significantly decreases the emissions of particulate matter and sulfur dioxide to the atmosphere. The installation was designed by the Canadian company WorleyParsons HG Engineering Ltd and the German company Lurgi Bischoff GmbH and consists of a wet scrubber, a dry scrubber and a baghouse filter, which operate continuously. The cleaned gases are emitted through the 325 m stack.

October 28, 2008

Opening of new refinery

The new refinery operates according to the latest technology in accordance with ISA 2000 (Australia). The process is managed and controlled by the automatic management system DCS 7. The construction of the new refinery was an € 82 million investment and was the largest industrial investment in Bulgaria for that period.



2008

Construction of the third sludge landfill

The third specialized landfill for calcium arsenate sludges was constructed and operates in full compliance with all environmental requirements, ensuring the highest protection of soil, surface water and groundwater.

October 7, 2010

Re-opening of renovated slag flotation installation

With the expansion of the slag flotation plant, the company reached a copper concentrate capacity of 800,000 t annually, which is an indicator of a significant increase of the previous capacities by 30%. The latest technology is implemented in the new facility – a new autogenous mill with a length of 7.8 m and a width of 6.5 m, three additional flotation cells (with 70 m³ volume each) and fully automated flotation and milling processes. In addition to the increased capacity of copper slag processing, the copper recovery rate has also increased, further improving the site's resource efficiency.

2012 – ongoing project

Utilization of waste materials and introduction of a new product in the product line

At the end of 2012, Aurubis Bulgaria AD was approved to receive European co-funding for a project for waste materials recycling and the introduction of a new product in the company's product line. The project is being financed by the Operational Programme "Development of the Competitiveness of the Bulgarian Economy" 2007-2013, funded by the European Union through the European Regional Development Fund and the national budget of the Republic of Bulgaria. The contract is for 50% grant assistance and is within the framework of the project "Investments in Green Industry", which is part of the Operational Programme. The project covers several components connected with the purchase and commissioning of new scrap processing equipment, as well as implementation of a filter press for fayalite drying, which will open up more possibilities for utilization of this by-product.



2014

Festive kick-off (from left): Bulgaria's Minister of Economy Bozhidar Lukarski, Deputy Minister of Environment and Water Krasimir Jivkov, former Aurubis Executive Board Member Dr. Frank Schneider, Aurubis Bulgaria Executive Director Tim Kurth and German Ambassador to Bulgaria Detlef Lingemann

November 18, 2014

Opening of rainwater treatment plant

The total amount of the environmental project was € 6.3 million and was funded by Aurubis. The activities were carried out in one year, covering the construction of a wastewater treatment plant with a capacity of 250 m³/h and buffer pools for incoming sewage. The new wastewater treatment plant treats rainwater and drainage water from the company premises, an area of 4 km², in order to reduce water emissions. The current technology is in full compliance with the best available techniques (BAT). Some of the purified water will be reused in the production process, thereby reducing the consumption of fresh water and protecting the environment.

2011-2014

“Aurubis Bulgaria 2014” investment program

This € 44.2 million project includes environmental measures amounting to € 26 million and aims to improve processes and optimize the environmental performance of the smelter. The project consists of expanding the concentrate dryer's baghouse filters, replacing the concentrate burner, expanding the smelting furnace's cooling system, as well as modifying and increasing

the heat exchange capacity of the boiler utilizer. The main environmental contribution of the project is the construction of a new secondary gas cleaning system. The new system will employ a modern sulfuric acid technology, Sulfacid, which will be unique for Bulgaria as well as for the global copper smelting industry. This new emissions control installation will further reduce the air emissions from the smelter.

Stakeholder dialogue

Talks with NGOs on the topic of sustainability

The public pays attention to whether a company acts responsibly now more than ever before. In order to understand this view better and to explain its own positions, Aurubis leads Stakeholder Dialogues with a number of interest groups such as customers and suppliers, policymakers, the capital market and the media. Seven meetings have taken place with selected environmental and social non-governmental organizations (NGOs) since spring 2014: Germanwatch, Deutsche Umwelthilfe, WWF, Rettet die Elbe, Transparency International, Südwind and Misereor.

Topics such as resource efficiency and recycling, responsibility in the supply chain, energy consumption, environmental impacts and the Sustainability Strategy were constructively discussed in a positive atmosphere. The dialogue should continue.

Aurubis Energy Day 2014

Under the motto “100 % Energy-Efficient in the Plant and at Home”, more than 500 employees gathered information about the efficient use of energy in the plant and at home during the first Energy Day at the Hamburg plant in July 2014.

Resource Protection and Environmentally Sound Recycling Management – Aurubis hosts panel discussion

Improved raw material use is a topic with increasing sociopolitical importance. On October 29, 2014 Reinhard Bütikofer, Member of the European Parliament for the Greens/European Free Alliance, Helge Wendenburg, Federal Environment Ministry, Alexander Porschke, German Nature and Biodiversity Conservation Union, and Frank Schneider, former Aurubis Executive Board Member, discussed these issues during the event “Resource Protection and Environmentally Sound Recycling Management”. About 100 guests from associations, politics, public authorities, organizations, media and industry accepted Aurubis Hamburg’s invitation to the discussion in the Alte Schlosserei event hall. Dirk Jepsen from Ökopool, a German institute for ecology and policy, moderated the event.

After the introduction, Jutta Blankau, Hamburg’s Senator for Urban Development and the Environment, described the development of resource protection in the past few decades, from the culture of waste disposal to the culture of value conservation. A lively discussion about the challenges and opportunities of improved raw material use and environmentally friendly recycling management followed.

On the panel at Aurubis (from l. to r.): Reinhard Bütikofer, Member of the European Parliament for the Greens/European Free Alliance, Helge Wendenburg, Federal Environment Ministry, Dirk Jepsen, Ökopool, Alexander Porschke, German Nature and Biodiversity Conservation Union, and Frank Schneider, former Aurubis Executive Board Member





Open dialogue with various interest groups is important to Aurubis – for example, during inaugurations of new plant facilities, in this case the rainwater treatment plant at the Pirdop site (center), and plant visits from policymakers and business leaders (right)

Olen – visit from diplomats and ministerial representatives in August 2014

In August 2014 seven representatives of the diplomatic service and various ministries of Belgium visited the Aurubis site in Olen in order to have a direct glimpse of copper processing and to discuss current political issues from different perspectives. The talk about new EU requirements was very interesting and informative for all of the participants. Aurubis employees discussed intensively with the representatives of the Ministry of Economic Affairs and the Ministry for Development Cooperation.

Visit from the North Rhine-Westphalia Environment Minister at the Lünen recycling center

On October 30, 2014 the Environment Minister of the German state of North Rhine-Westphalia, Johannes Remmel (Alliance 90/the Greens), visited the Aurubis recycling center in Lünen. In addition to an extensive plant tour, issues including recycling management, emissions trading and the German Substitute Building Materials Ordinance were discussed together with two representatives of the Arnsberg district government.

Metals pro Climate

The corporate initiative “Metals pro Climate” unites the producers and processors of non-ferrous metals (NF metals) such as aluminum, copper, zinc, magnesium, nickel and lead under the German Economic Association for Metals. The members show how efficient plant technology in production, products made of NF metals for climate protection technologies and modern recycling can contribute to resource conservation and climate protection.

For example, in 2014 Aurubis participated in a discussion on the topic “NF Metals – Slowing Down or Speeding Up the Energy Shift?” during a regional event.

Audits

Every year, five to ten audits of electronic scrap suppliers are carried out at Aurubis Lünen. Producers of electronic devices such as Apple, Daimler, DOW and Flextronics, which deliver their e-scrap directly or indirectly to the Lünen recycling center and have it processed there, are obligated to ensure that their material streams are recycled in an environmentally sound and legal manner.

Aurubis can justifiably present itself publicly as a responsible company. Stakeholders of all kinds, such as NGOs and secondary raw material customers in particular, come to the Aurubis plant, pose detailed questions and observe all of the processes. Aurubis defines increasingly high standards for its corporate activities. Audits provide an opportunity for the company to measure its own standards, reviewing them and redefining them as necessary.

High-level visitors at the inauguration of the new water treatment plant in Pirdop

On November 18, 2014 another environmental protection project was completed at Aurubis Bulgaria in Pirdop: the start-up of a rainwater treatment plant, which will treat all of the site’s rainwater and drainage water (see p. 31). The festive inauguration of the facility was attended by Bulgarian President Rosen Plevneliev, Ambassador of the Federal Republic of Germany to Bulgaria Detlef Lingemann and Aurubis Bulgaria Managing Director Tim Kurth. Official guests included the mayor of the neighboring towns of the plant, Pirdop and Zlatitsa, representatives of the company that constructed the facility, business partners, the heads of the professional associations and the Ministry of Environment and Water as well as company employees.

Technical Environmental Protection:

an important pillar

The continuously changing compositions of metallic and non-metallic materials in ore concentrates and recycling materials require constant adjustment of the process and plant technologies.

As a result, Technical Environmental Protection is an important pillar of environmental protection at Aurubis: experienced employees with specialized knowledge of process technology and complex metallurgical methods

continuously work on reducing possible environmental impacts. This also requires a willingness to break new ground and implement innovative technologies. Ongoing analysis and adjusted assessments are crucial in this case. Samples and recordings for immission protection, water pollution control, soil conservation and occupational safety are carried out using standardized and officially recognized methods.

All of the processes and plant technologies utilized at Aurubis are designed to minimize environmental impacts. One example: the facility for recovering precious metals from anode slimes at the Hamburg site





State-of-the-art process gas cleaning in the facility used to recover precious metals from anode slimes



Technical Environmental Protection is active in the Group as an adviser, initiator and moderator. Here, Orhan Cekel (Hamburg) and Diana Dimitrova (Pirdop) prepare special equipment to record fugitive emissions and calculate grain sizes

The data collected – several thousand individual samples and countless individual analyses in the Group over the year – help to minimize environmental effects, enable more effective operating processes and are the basis for investment decisions. The correct calculation of the data resulting from long-term experience and very good knowledge of the recording and sampling technology are vital conditions for reproducible and reliable results.

Current examples of excellent technical environmental protection include process optimization and emission reduction: for instance, the new anode slime plant in Hamburg. This plant allows Aurubis to process all of the precious metal-bearing anode slimes from the Group optimally at the Hamburg site and to recover high-purity silver and fine gold. The capacity was expanded and the process technology was improved. The anode slime is now dried in a one-step filter press process, which saves 35 % of the energy and reduces the CO₂ emissions by 460 t per year.

The analysis of sources of fugitive emissions is an especially complex discipline. A good example of this is the construct a new off-gas treatment plant (filtration) in primary copper processing in Pirdop with an environmental protection investment of € 26 million. The fugitive emissions of the production building were recorded over six days in an extensive research program (40 recording stations, 650 individual analyses overall), creating a reliable basis for the investment decision.

The progressive standard for the reduction of fugitive emissions that has been achieved is being established and harmonized across the Group. For instance, the Hamburg, Lünen and Pirdop sites have already achieved reductions in fugitive emissions of up to 90 %. Due to the exchange of experiences across the sites, additional technical and organizational optimizations in plant technology (off-gas and wastewater treatment) and in the demand for energy and operating supplies are being identified and implemented.



Orhan Cekel

»The extensive experience in process and plant technology in copper production that we have collected over decades provides an excellent basis for generating additional optimizations for the entire Group with the Aurubis network of interdisciplinary experts.«

Head of Corporate Technical Environmental Protection, Hamburg

Environmental management

We assume responsibility for environmentally friendly production with the highest energy efficiency standard for climate protection and have established these targets in our company guidelines (see p. 10). Alignment with the market, orientation towards growth, a clear commitment to efficiency and continuous improvement processes, high quality awareness in all sectors and ecological and social responsibility: all of these factors secure the future of the Group.

We pursue goal-oriented environmental protection with state-of-the-art technology. Expanding recycling in the Group helps to close material cycles in an environmentally sound manner and therefore makes an important contribution to sustainable development. Beyond legal requirements, voluntary agreements like the chemical industry's "Responsible Care" initiative are important instruments for Aurubis to continuously improve its environmental and health protection performance.

Chief Representative Primary Copper Dr. Thomas Bünger and Head of Corporate Environmental Protection Dr. Karin Hinrichs-Petersen are responsible for the strategic orientation of environmental protection in the Group. Environmental Officers oversee the environmental duties at the individual sites. With the involvement of employees, Plant Managers/Managing

Directors and the Executive Board, uniform environmental protection standards were developed for the Aurubis Group, established with corporate guidelines and implemented across the Group as part of the Environmental Management System (ISO 14001 or EMAS).

The key environmental protection factors, which are uniform within the Group, are reviewed and certified annually.

Environmental communication takes place across the Group and employees are trained on environmentally relevant topics regularly.

Emergency plans or alarm and danger prevention plans have been established for emergencies and accidents. They ensure that environmental impacts are effectively avoided and that employees and the community are protected. We carry out training sessions and emergency drills regularly, documenting and evaluating the procedures. Emergency plans are developed in coordination with the responsible authorities.

The corporate environmental protection guidelines also include the tasks to implement the European chemical directive, REACH (see p. 26).

Fig. 12: **Organizational chart**

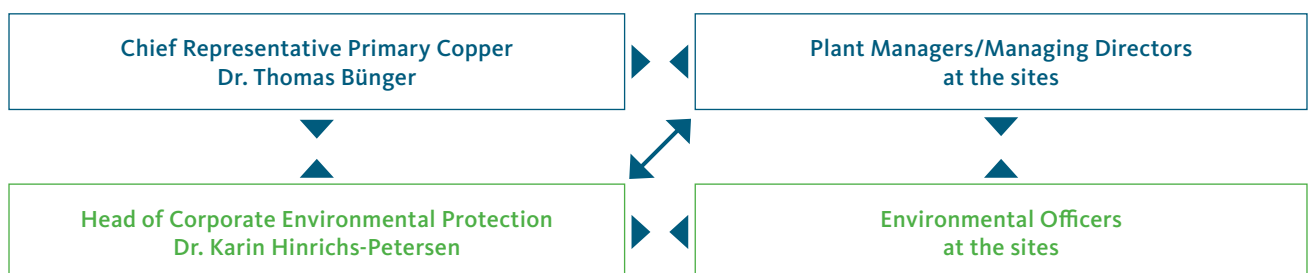

Fig. 13: Environmental management in the Aurubis Group

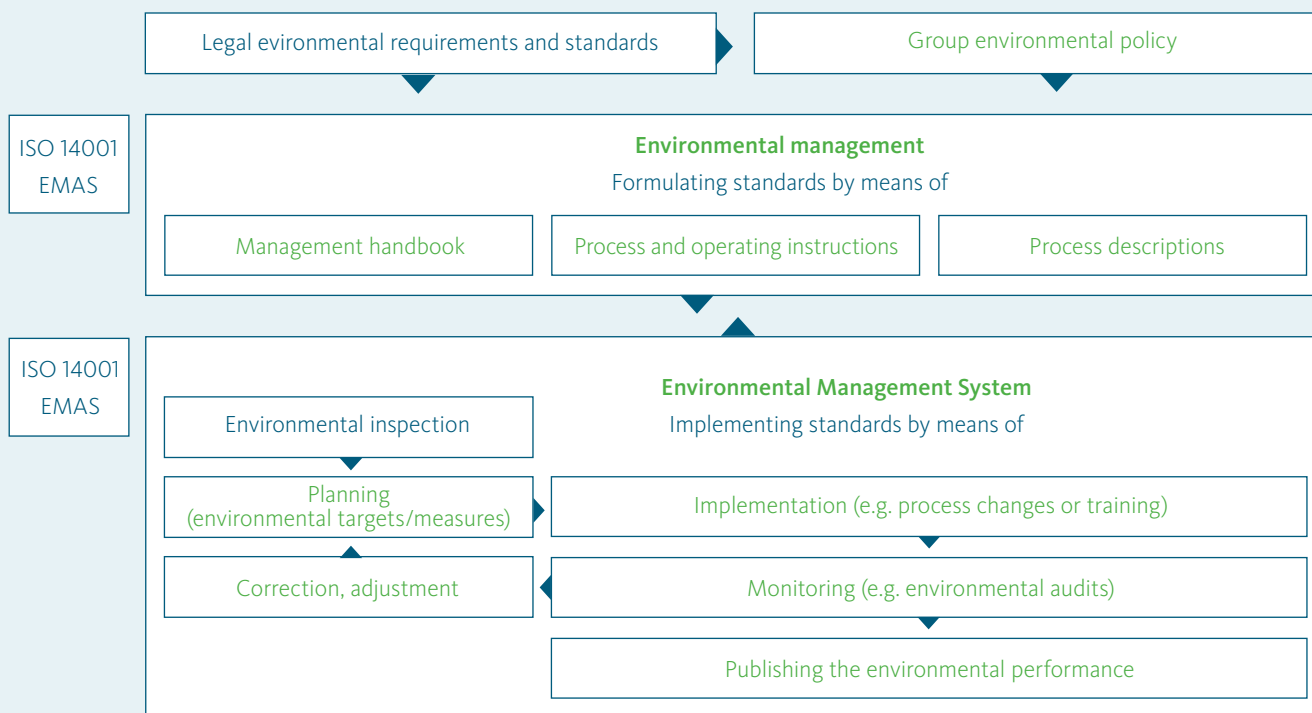

Fig. 14: Certifications by site

Site	EMAS	ISO 14001	ISO 50001	ISO 9001	TS 16949	Efb
Hamburg, headquarters (DE)	x	x	x	x		
Lünen (DE)	x	x	x	x		x
Pirdop (BG)		x		x		
Olen (BE)		x		x		
Fehrbellin, CABLO (DE)		x	x	x		x
Nersingen, Strass, CABLO (DE)		x	x	x		x
Hamburg, E.R.N. (DE)		x		x		x
Buffalo (USA)				x	x	
Pori (FI)		x		x		
Avellino (IT)		x		x		
Zutphen (NL)		x		x	x	
Stolberg (DE)			x	x	x	
Emmerich, Deutsche Giessdraht (DE)		x	x	x		
Stolberg, Schwermetall (DE)	x	x	x	x		
Röthenbach, RETORTE (DE)				x		
Hamburg, Peute Baustoff (DE)				x ¹		

EMAS: system with guidelines for environmental management systems and environmental audits

ISO 14001: standard for environmental management system guidelines

EN ISO 50001: standard for energy management system guidelines

EN ISO 9001: standard for quality management system guidelines

TS 16949: standard for quality management system guidelines for the automotive industry, based on ISO 9001

Efb: Waste Management Company (certificate in DE)

¹ For the sale of iron silicate granules used to produce blasting abrasives

Site Reports

7

Aurubis Group production sites

Page

			Page
1	Aurubis AG, Hamburg	Hamburg, headquarters (DE)	40
2	Aurubis Bulgaria AD	Pirdop (BG)	42
3	Aurubis AG, Lünen	Lünen (DE)	44
4	Aurubis Belgium nv/sa	Olen (BE)	46
5	Schwermetall Halbzeugwerk GmbH & Co. KG ¹	Stolberg (DE)	48
6	Aurubis Stolberg GmbH & Co. KG	Stolberg (DE)	50
7	Aurubis Buffalo Inc.	Buffalo (US)	52
8	Aurubis Netherlands BV	Zutphen (NL)	54
9	Aurubis Finland Oy	Pori (FI)	56
10	Aurubis Italia Srl	Avellino (IT)	58
11	Deutsche Giessdraht GmbH ²	Emmerich (DE)	60
12	CABLO Metall-Recycling & Handel GmbH	Fehrbellin (DE)	62
13	CABLO Metall-Recycling & Handel GmbH	Strass (DE)	62
14	Elektro-Recycling NORD GmbH	Hamburg (DE)	64
15	RETORTE GmbH Selenium Chemicals & Metals	Röthenbach (DE)	66
16	Peute Baustoff GmbH	Hamburg (DE)	68

¹50% holding ²60% holding

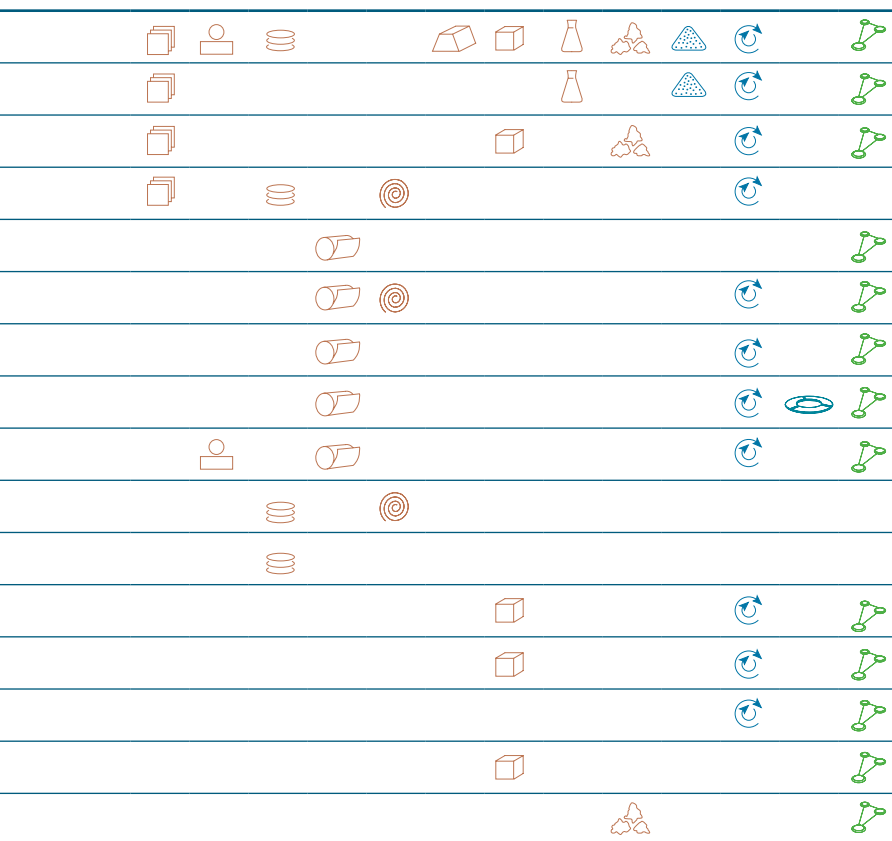
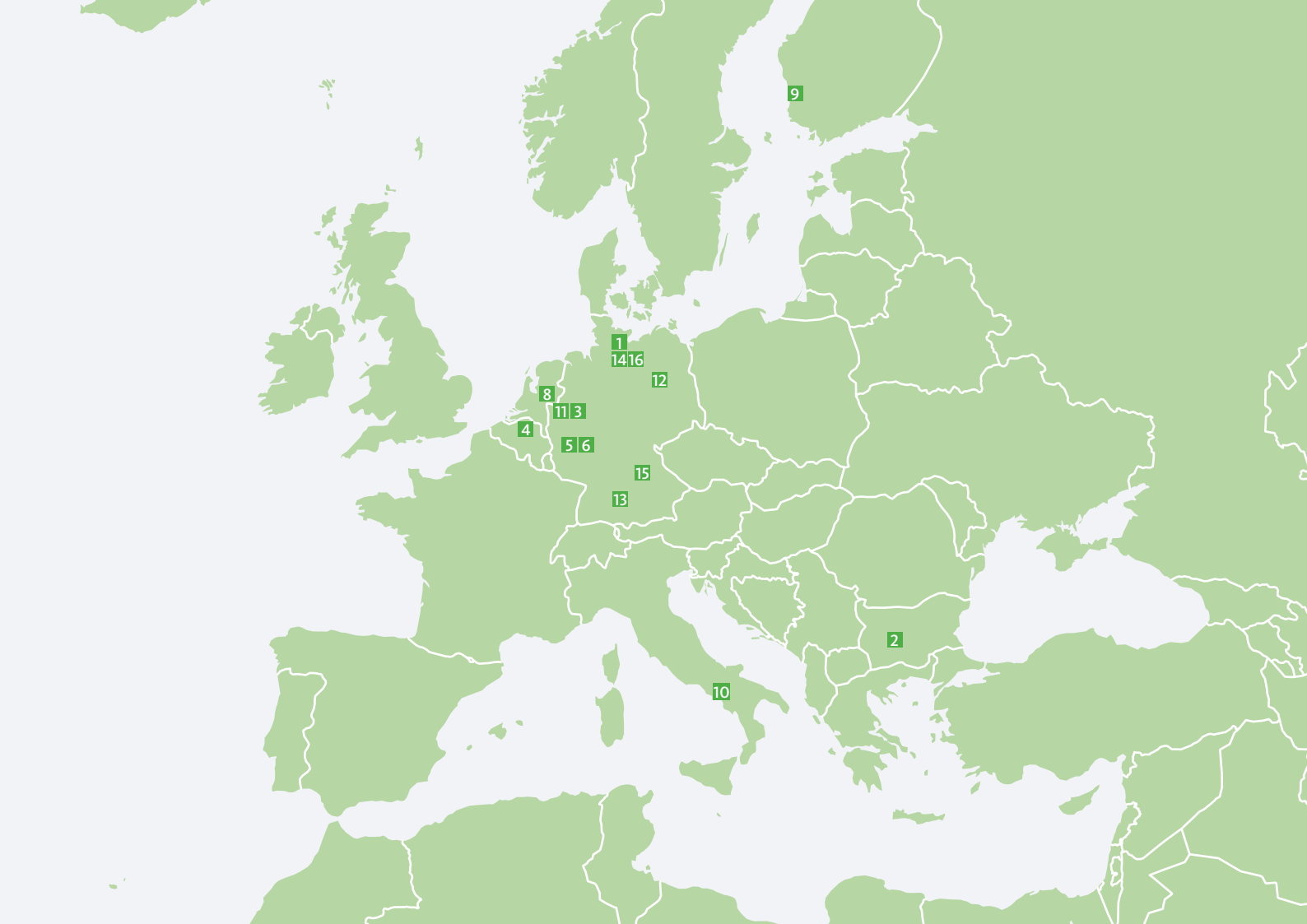

Products

The copper is processed into products. Some products are already the result of copper production.

- Cathodes
- Precious metals
- Rod
- Sulfuric acid
- Shapes
- Iron silicate
- Strip/foil
- Other metals
- Specialty wire, drawn products

Raw Materials

Concentrates and recycling materials are the raw materials from which copper is produced.

- Concentrates
- Recycling material

Slitting Centers

Services centers located near our customers slit strip to the desired dimensions.







Sales and Distribution Network

An international sales and distribution network markets our products.

Aurubis AG, Hamburg

located in Hamburg, Germany

- » Largest site and administrative headquarters
- » Certifications: EMAS, ISO 14001, ISO 50001, ISO 9001
- » Business segments: Primary Copper, Recycling/Precious Metals, Copper Products

 Cathodes 375,240 t	 Sulfuric acid 1,254,270 t	 Iron silicate 780,240 t
 Gold, silver, selenium 1,499 t	 Rod 253,000 t	 Shapes 186,000 t

Site size:
870,000 m²

Number of employees:
2,312

Group
total:
6,503

Central environmental targets and measures

Measure	Degree of implementation/Date/Next steps	Status
Reducing dust emissions by 9 t per year		
Construction of a bulk goods warehouse with an integrated crusher to reduce fugitive emissions from the northern storage area	The project has been completed.	✓ Successfully completed
Feasibility study on further reducing fugitive emissions in the primary copper production sector	The assessment was issued in 2013. As a follow-up, an optimization of local exhaust ventilation on the converter vessels is already being projected. The next steps for implementation are being reviewed in cooperation with the Hamburg Authority for Urban Development and the Environment. The measure should be completed in late 2015.	→ In progress
Increasing energy efficiency in the RWO		
Constructing and operating a turbine to produce electricity from waste heat in the primary copper production sector (CO ₂ reduction of 5,000 t annually)	Completed in 2013, commissioned in November 2014	✓ Successfully completed
Reducing the heat emitted into the Elbe		
Limiting the emitted heat by releasing cooling water at the main discharge points and optimizing operations	Implementation through a water law permit for cooling water discharge	→ In progress
District heating (about 18 to 60 MW) from the sulfuric acid plant	Part of the project "Northern German Energy Shift 4.0" of the regions Hamburg and Schleswig-Holstein, concept to be developed by late 2015	→ In progress
Participation in the Partnership for Air Quality		
Involvement in the city of Hamburg's Partnership for Air Quality and Mobility	Drafting concepts of implementation ideas: <ul style="list-style-type: none"> » Development of a concept for introducing e-bike leasing by March 2015 » Construction of a bike box at the Veddel train station » Improved transport options to the plant with public transport or a company bus shuttle 	→ In progress

Please see the Environmental Statement 2015 for additional targets and measures in Hamburg as well as other information.

Hamburg site environmental portrait

The largest Aurubis AG production site and the Group headquarters is located on an area of about 870,000 m² on the Elbe island Peute, only about four kilometers as the crow flies from Hamburg's city hall.

The plant was constructed in 1908 in Peute, an industrial inland harbor area in the Veddel district. Following re-

construction after World War II, the production facilities were continuously expanded and steadily modernized. Today, Aurubis AG's Hamburg site is one of the world's state-of-the-art primary and secondary copper smelters and produced about 375,240 t of copper cathodes in 2014. 2,312 personnel are employed at the Hamburg site, including around 180 apprentices.



»We feel especially committed to environmental and climate protection as an integrated copper producer in the middle of metropolitan Hamburg. Energy-efficient production processes that conserve resources are therefore just as important to us as converting almost all of the input materials into marketable products.«

Thoralf Schlutzkus, Plant Manager (left)
Arne Schilling, Environmental Officer (right)

The main raw materials in copper production are copper concentrates (processed copper ores) and recycling materials (including electrical and electronic scrap). Pure copper results from the different raw materials following the smelting process in the tankhouse. Additionally, precious metals, nickel, lead and zinc as well as iron silicate products and sulfuric acid are obtained from – in some cases – very complex input materials in the scope of multi-metal recycling. Aurubis uses the properties of copper and other metals to enable recycling without a loss of quality.

About € 19 million was invested in the new lead refinery commissioned in May 2015. This facility recovers marketable high-purity lead from lead-bearing recycling intermediates on the one hand and concentrates and extracts the precious metals contained for further processing in the precious metal smelter on the other. A 50% reduction in fugitive emissions compared to the previous facility is expected as a result of the optimized material flow and the efficient hall ventilation concept. In addition, the new facility enables increasingly complex materials to be processed.

Dust emissions

- » Projects to reduce fugitive emissions currently take top priority following the focus on direct emissions in the 1990s. It is therefore crucial for Aurubis to develop innovative environmental protection technologies, breaking new technical ground in the process.
- » Dust emissions have been reduced by 83% since 1990. The nominal increase in 2011 is based on the authorities' new nationwide calculation standards. Dust emissions did not actually increase.

Dust in g/t of copper output (including fugitive emissions)

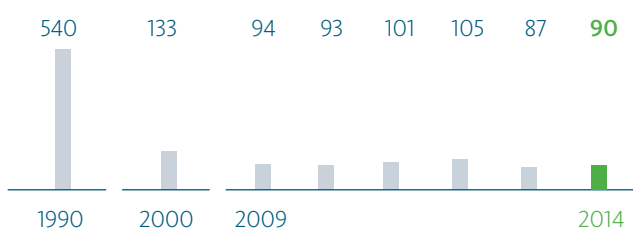

Specific energy consumption

- » The main energy sources at the Hamburg site are electricity and natural gas.
- » Specific energy consumption has stagnated at the Hamburg site during the past few years due to the increase in multi-metal recycling. This leads to higher total energy consumption but not a higher copper quantity.
- » In the long-term view, specific energy consumption, which is the main indicator for energy-efficient production, has decreased significantly at the Hamburg production site in the last several years – by 45% compared to 1990.

Specific energy consumption in MWh/t of copper output

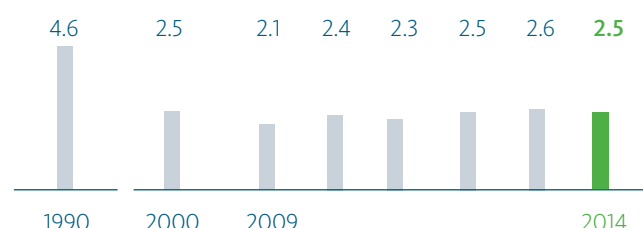

Aurubis Bulgaria AD

located in Pirdop, Bulgaria

- » Link to the Southeast European market
- » Certifications: ISO 14001, ISO 9001
- » Raw material input: 1,200,000 t of concentrates and 60,000 t of recycling material
- » Business segment: Primary Copper



 Cathodes
230,000 t

 Sulfuric acid
1,200,000 t

Site size:
4,000,000 m²

Number of employees:
822

Central environmental targets and measures

Measure	Degree of implementation/Date/Next steps	Status
Reducing air emissions		
Investment project "Aurubis Bulgaria 2014" with a capital expenditure volume of € 44.2 million, € 26 million of which is allocated to environmental protection measures:		→ In progress
(1) increasing the concentrate drying plant's filter capacity;	(1) is completed	
(2) extensive collection and cleaning of fugitive emissions in a new filtration plant	(2) is in progress and will be commissioned by August 2015	
Reducing emissions to surface water		
Constructing an additional wastewater treatment plant for cleaning rain and surface water	Construction started in July 2013 and the new plant was commissioned in November 2014.	✓ Successfully completed
Increasing the recycling rate		
Stronger marketing of fayalite	Expanding efforts to sell fayalite as an aggregate for cement production in neighboring countries	→ Ongoing
Optimizing soil and groundwater protection		
Developing a detailed action plan for soil and groundwater protection with short-term and long-term measures	The action plan will be developed by the end of 2015.	→ In progress

Pirdop site environmental portrait

The plant in Pirdop, Bulgaria provides Aurubis with access to the Southeast European market. Its main products are copper anodes, copper cathodes and sulfuric acid.

The smelter was built between 1955 and 1958 near the city of Pirdop. The first copper anode was produced on November 21, 1958 and the plant was officially opened on December 6 of the same year. It has gradually been

upgraded into a highly modern facility. Since the company was privatized in 1997, almost € 500 million has been invested in the site to modernize the processes and improve the site's environmental performance.

Environmental protection continues to be a priority, and in 2013 around 80 % of all capital expenditure at the Pirdop site was for environmental projects.



»The construction of the new wastewater treatment plant for rain and surface water is an important step towards ensuring 100% compliance with the water emission standards. This facility is a € 6.3 million investment, equipped with modern technologies and large retention basins. This is the third wastewater treatment plant on site, which makes Aurubis Bulgaria the only company in Bulgaria which has specialized treatment facilities for all its wastewater streams.«

Tim Kurth, Executive Director (left)
Angel Kostov, Head of Environmental Protection and Occupational Health (right)

Currently, two state-of-the-art environmental protection facilities are under construction or are being commissioned. A new wastewater treatment plant started up in November 2014 and a gas treatment plant was completed and is scheduled for commissioning in 2015. These installations will further reduce emissions to air and water, thus enhancing the company's environmental performance.

Aurubis Bulgaria has implemented an Environmental Management System, which has been ISO 14001-certified since March 2006. The plant was recertified by external auditors in 2012 and again in February 2015.

The site in Pirdop has been part of the EU Emissions Trading Scheme since 2008. The site has consistently improved its energy efficiency over the years. It is the site's ambition to invest in additional environmental measures and energy efficiency enhancements.

Sulfur dioxide emissions

» The low level of air pollution in the Pirdop plant area today is a result of the continuous development of the production processes and the permanent operation of the gas cleaning system. The secondary off-gases' sulfur dioxide values (all captured emissions) are well below the limits established in the EU's IPPC directive.

Sulfur dioxide in kg/t of copper output

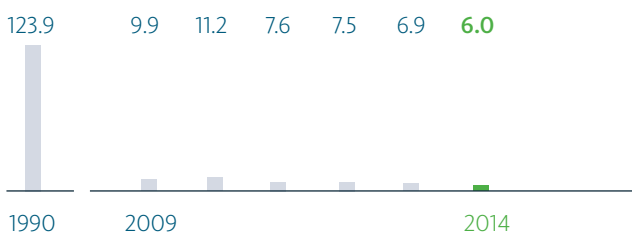

Dust emissions

» Specific emissions of dust have been reduced by over 99% since 2000. The values have decreased again and clearly show how successfully the measures of the investment project "Aurubis Bulgaria 2014" contribute to reducing emissions to air.

Dust in g/t of copper output

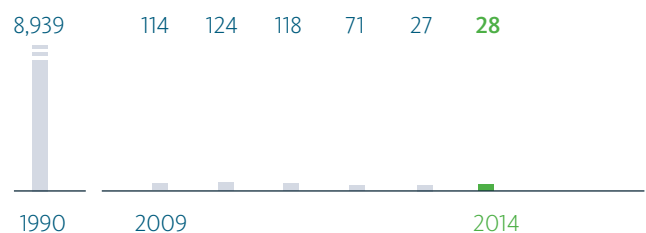

Aurubis AG, Lünen

located in Lünen, Germany

- » Largest copper recycling site worldwide
- » Certifications: EMAS, ISO 14001, ISO 9001, ISO 50001, Waste Management Company (material preparation sector)
- » Business segment: Recycling/Precious Metals



 Cathodes 193,000 t
  Iron silicate sand 186,000 t
  Other by-products (nickel sulfate, tin-lead, KRS-oxide, etc.) 34,000 t

Site size:
316,000 m²

Number of employees:
585

Central environmental targets and measures

Measure	Degree of implementation/Date/Next steps	Status
Improvements in off-gas treatment in the anode furnace		
Anode furnace off-gas treatment with a new additive for effective material recovery and a test for post-combustion of the off-gas for carbon reduction	Following successful tests, the carbon-based additive is continuously blown into the off-gas. The tests for off-gas post-combustion have been put on hold for the meantime. The carbon values in the off-gas are currently much lower.	→ In progress
Optimizing wastewater streams		
Separate treatment of sanitation water	There is already a concept and detailed plans are being coordinated with the relevant authorities.	→ In progress
Increasing energy efficiency		
Covering at least 10% of the plant's electricity demand by using a steam turbine to produce electricity internally	The turbine has been approved and commissioned; its integration in the plant processes is currently being optimized.	✓ Successfully completed

Please see the Environmental Statement 2015 for additional targets and measures in Lünen as well as other information.

Lünen site environmental portrait

Aurubis AG's Lünen plant was commissioned in 1916 as a branch plant of Hüttenwerke Kayser. Norddeutsche Affinerie AG acquired the majority of Hüttenwerke Kayser AG shares in 2000 and the plant was expanded to become the Group's recycling center. In the meantime, the site has 585 employees, including about 40 apprentices.

Today, Aurubis AG's Lünen site is the largest secondary copper smelter in the world. In 2014 the plant produced 193,000 t of copper cathodes.

In addition to the usual recycling raw materials like copper scrap and other scrap, slimes and residues, complex materials are increasingly used in copper production, especially electrical and electronic scrap. This corresponds to the strategy of multi-metal recycling, which contributes to the constant increase in metal production from recycling raw materials in the Group (see the graphic in the environmental protection chapter).



»In 2013 the long-term emission reduction program at the site, which included the complete closure of the smelting operations' ridge turret, was successfully concluded. This step sustainably improved the emission situation surrounding the Lünen plant once again.«

Astrid Herbers, Plant Manager (left)
Dr. Hendrik Roth, Environmental Officer (right)

The core facility for metallurgical processes has been the Kayser Recycling System (KRS) since 2002, which was supplemented by a so-called TBRC in mid-2011. Zinc-bearing KRS oxide, iron silicate sand (slag granules), tin-lead alloy, nickel and copper sulfate as well as anode slimes are produced as by-products of multi-metal recycling.

The primary smelter's new additional filter has been in operation for the entire year for the first time in 2014 and, as expected, improved emissions significantly once again. Dust emissions decreased from 3,300 kg (2012, old filter only) to 250 kg (new filter).

During 2014 a comprehensive concept for modernizing the electrolyte cycles was drafted that will enable a much more efficient recovery of by-metals, especially nickel, from the process in a targeted way. In the course of this update, a number of modernization measures were planned in the tankhouse and leaching plant and environmental protection was improved further. This includes the relocation of filling processes inside the hall, additional suction equipment and the construction of new, efficient cooling towers for the leaching plant.

Dust emissions

- » Emissions of dust and dust components (Cu, Pb, As, etc.) have decreased significantly at the Lünen site due to reduction measures during the past few years. The figures shown also incorporate fugitive emissions, including storage and transshipment. The moderate increase in 2011 is a result of new national calculation standards established by the responsible authorities.
- » Only about 1% of the total emissions of dust and dust components originate from the TBRC.

Dust in g/t of copper output

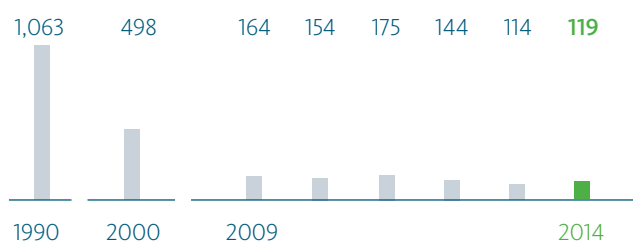

Specific energy consumption

- » Energy is primarily used to heat the metallurgical plants (mainly heating oil) and for the tankhouse (electricity). The KRS and anode furnace waste heat boilers produce most of the steam for the leaching plant and tankhouse. There are also two extra boilers fueled with light oil and natural gas.
- » The energy consumption for the throughput increases in the KRS and the anode furnaces was largely compensated for by increasing energy efficiency.
- » One-third of the electricity demand at the Lünen site is required for environmental protection measures.

Specific energy consumption in MWh/t of copper output

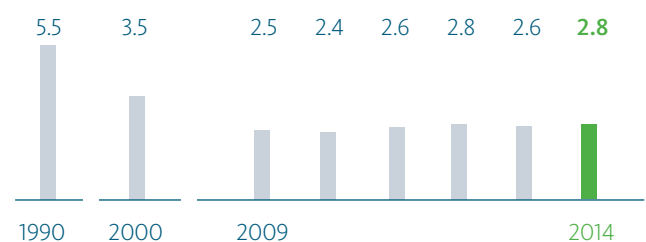

Aurubis Belgium nv/sa

located in Olen, Belgium

- » Link to the West European market
- » Certifications: ISO 14001, ISO 9001
- » Business segment: Primary Copper, Recycling/Precious Metals, Copper Products



 Cathodes
340,166 t

 Rod
223,430 t

 Specialty rod
26,747 t

 Bars & Profiles:
9,215 t

Site size:
328,000 m²

Number of employees:
505 (Olen), 26 (Brussels,
administrative office)

Central environmental targets and measures

Measure	Degree of implementation/Date/Next steps	Status
Reducing air emissions		
Improving the exhaust system of the Contimelt plant: the 4-step project started at the end of 2011 and lasted until 2013.	Quench and cyclone treatments were installed in the anode shaft furnace's exhaust gas circuit in December 2011. The second filter went into operation in January 2013.	✓ Successfully completed
Measures to reduce dust emissions from the scrap yard and roads	Installation of additional spraying nozzles and mobile spraying tractor to keep the scrap yard and roads wet: finished at the end of 2013	✓ Successfully completed
Use of isopropyl alcohol in the Contirod plant (reduction of volatile organic compounds, VOCs)	The use of isopropyl alcohol was strongly reduced and ceased completely at the end of 2012.	✓ Successfully completed
Reducing CO₂ emissions		
Constructing a heat recovery system for the Conform facility	Completed in July 2012	✓ Successfully completed
Installation of four wind turbines in a joint project with Electrabel (electricity producer), Umicore and Aurubis	The environmental permit was issued in June 2014 and the building permit was issued in July 2014. Construction is scheduled for 2016.	→ In progress
Improving water conservation		
Project to install an effluent pipeline directly from the plant to the river Kleine Nete in order to conserve the natural reserve "Olens Broek"	Routing has been coordinated and engineering has started. To be completed in late 2015	→ In progress
Study and actions to further reduce metal emissions to water, especially cobalt and cadmium	The study was finished in June 2013. Full-scale testing was carried out in 2014. Implementation will take place in 2015.	→ In progress
Optimization of waste/by-product processing		
In order to re-assess metals in by-products and process waste, reuse within the group is being investigated and implemented.	Application for authorizations in 2014/15	→ In progress

Olen site environmental portrait

Aurubis Belgium in Olen is the gateway to the West European market. About 530 people are employed at Aurubis Belgium, some of whom work at the administrative office in Brussels. In 2014 the Olen plant produced 340,166 t of cathodes, 223,430 t of rod, 26,747 t of specialty rod and 9,215 t of profiles.

During the past several years, the Olen site has successfully increased its input of recycling materials. The proportion of these materials rose from 34% to 40% between 2009 and 2014 (see the graph on the following page). However, this increase poses high challenges to the treatment of air emissions, leading to extensive measures. In the past three years, more than € 4.5 million has therefore been invested in environmental protection.



»The reduction of metal emissions to air and water still is a main focus of environmental protection at the Olen site. However, in our efforts to 'close the loop', the recovery of metals and the extraction of marketable by-products is becoming more important – to conserve natural resources, among other things.«

Filip Lecomte, Environmental Officer (left)
Jo Rogiers, Plant Manager (right)

In addition to reducing air emissions, the focus in 2014 has been on reducing water emissions as well.

A program to reduce the use of isopropyl alcohol in the Contirod rolling mill ended in the complete elimination of volatile organic compounds (VOCs) at the end of 2012. Additionally, spraying nozzles and a special spraying tractor were installed in late 2013 to keep the scrap yard and roads wet.

In order to re-assess metal content and limit landfilling, several by-products and production wastes will be sent to other sites within the Group.

To lower the influence of wastewater on the Olen Broek natural reserve, a new effluent pipeline will be built by the end of 2015

The construction of four wind turbines in Olen is planned as part of a joint project involving Electrabel (an electricity producer) in cooperation with Umicore and Aurubis. The environmental permit and the building permit for this project were issued in 2014.

Metal emissions in water

» The ongoing optimization of wastewater treatment and a new chemical reactor have considerably reduced the metal emissions in surface water in the past few years and kept it at a low level.

Metal in g/t of copper output

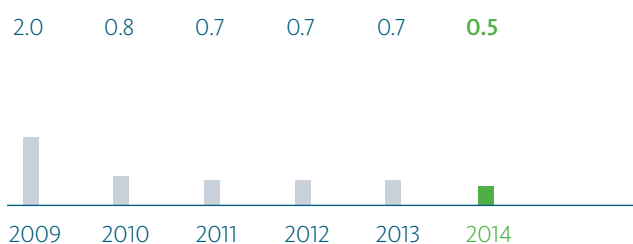

Proportion of recycling material in overall material input

» The proportion of recycling material in the overall material input is rising steadily.
» Recycling material accounted for 40% of Aurubis Belgium's material input in 2014.

Recycling material in %

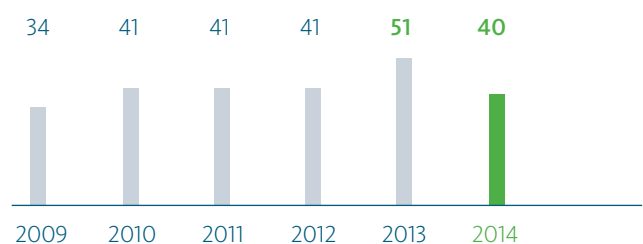

Schwermetall Halbzeugwerk GmbH & Co. KG

located in Stolberg, Germany

- » Specialist in prefabricating strip
- » Certifications: EMAS, ISO 14001, ISO 50001, ISO 9001
- » Business segment: Copper Products



Pre-rolled strip
220,300 t

Site size:
233,000 m²

Number of employees:
144¹

Central environmental targets and measures

Measure	Degree of implementation/Date/Next steps	Status
Improving energy efficiency		
Converting cooling water delivery in the casting line and rolling mill to pumps that can be controlled according to demand	Conversion carried out in the casting line, rolling mill will follow in late 2014	✓ Successfully completed
Improving energy efficiency in casting line 3 by commissioning an additional melting furnace for smaller lot sizes	In place since July 2014	✓ Successfully completed
Reducing off-gas losses in casting line 3's induction furnaces by using furnace covers	In operation since February 2014	✓ Successfully completed
Renovating and installing a demand-oriented suction system on a filter and the milling machine	Finished in January 2013. Delay due to limited technical implementation capacity	✓ Successfully completed
Reducing fugitive dust emissions		
Constructing a hall for loading dross	Construction started in April 2014, commissioning in fall 2015	→ In progress
Reducing emissions to air		
Improving off-gas collection with new suction systems on casting line 3's induction furnaces	In operation since February 2014	✓ Successfully completed

Environmental portrait of Schwermetall Halbzeugwerk, Stolberg

The 50% Aurubis subsidiary Schwermetall Halbzeugwerk produces pre-rolled strip made of copper alloys. Virgin metals and scrap are melted in the foundry and cast into cake, which is processed into pre-rolled strip in the rolling mill. The site has five filter facilities and two wastewater treatment plants.

Environmental protection has been an important element of corporate policy since the company was founded in 1972, in particular because the plant is surrounded by nature preserves. In 1995 Schwermetall Halbzeugwerk was one of the first companies in Europe to introduce an Environmental Management System in accordance with EMAS, which has also been certified in accordance with the international standard ISO 14001 since 2001.

¹ corresponding to Aurubis shareholding of 50%



»Environmental protection is a matter of course for us, an obligation and a challenge at the same time. It is a central element of our company philosophy, a significant component of our corporate responsibility and has had the highest priority in all of our processes since the company was founded in 1972. We therefore secure our company's long-term success and contribute to maintaining a clean environment for future generations.«

Dirk Harten, Plant Manager (left)
Dr. Karsten Neumann, Technical Foundry Manager (right)

The energy management system was developed beyond the requirements of these standards and has also been certified pursuant to ISO 50001 since 2013. Comprehensive information on environmental protection can be found in the annually updated Environmental Statement. The Environmental Management System is regularly reviewed by an external expert. The company's main environmental issues include saving energy and reducing fugitive dust emissions.

Please visit www.schwermetall.de for additional information about environmental protection at Schwermetall as well as contact information for ordering the Environmental Statement.

Process chain for pre-rolled strip made of copper materials

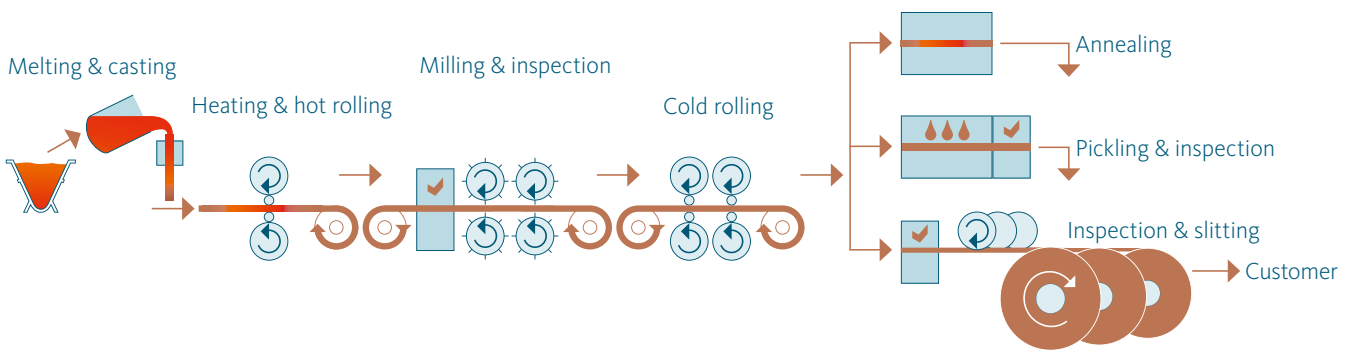

Production waste: recycling and disposal

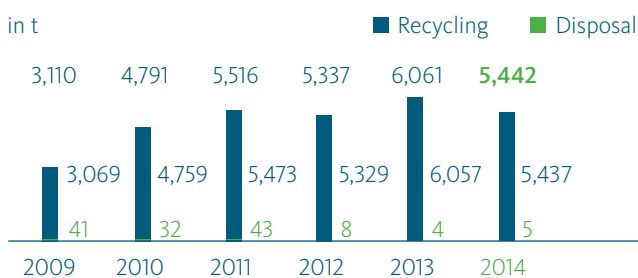

- » The disposal routes are regularly reviewed and optimized. The goal is to find an ecologically and economically sound disposal option for all waste.
- » The amount of waste is mainly proportional to production. In addition, changes in the product mix have led to more metal-bearing residues with higher value added.

Aurubis Stolberg GmbH & Co. KG

located in Stolberg, Germany

- » Supplier of strip, foil and shaped wire for various applications
- » Certifications: ISO 9001, ISO 50001, TS 16949
- » Business segment: Copper Products

Group total:
6,503

  Shaped wire, strip
45,500 t

Site size:
45,000 m²

Number of employees:
396

Central environmental targets and measures

Measure	Degree of implementation/Date/Next steps	Status
Optimizing water pollution control		
Restoring the plant's sewer network	Restoration of the plant's sewer network continued. Additional parts were overhauled during the reporting period, leaving only one part left before completion. All measures will be finished by 2020.	→ In progress
Installing hydraulic groundwater protection in the area of the former roll stands	A restoration concept was coordinated in consultation with the authorities. The facility was installed and commissioned. The facility is expected to run until 2020.	✓ Successfully completed
Lining the rolling cellar	The cellar was lined using an oil-resistant laminate structure (glass fiber reinforced plastic).	✓ Successfully completed
Reducing energy consumption		
Compressed air production	Modernizing the compressed air system by installing RPM-regulated compressors and an overarching compressor control	✓ Successfully completed
Modernizing the plant's internal cooling tower with the newest energy-efficient technology	Restoration and renovation of the water coolers (cooling towers) and separation into a primary cycle (cooling tower) and a secondary cycle (ring main to the consumers). The two systems were separated via a plate heat exchanger.	✓ Successfully completed
Optimizing the rolling mill hall's lighting	Replacement of the mercury vapor lamps with LED lights. This has already been completed in parts of the hall. They will all be replaced by September 2015.	→ In progress
Substituting the steam supply by installing a condensing gas boiler connected with the waste heat of the air compressors	The steam supply has been disconnected.	✓ Successfully completed
Saving costs by restructuring the internal cooling water cycle	First sub-step: disconnecting the roof drainage from the cooling circuit. The permit applications have been submitted to the district government. The measure is scheduled to be completed successively by fall 2016.	→ In progress
Reducing rolling oil losses		
Installing more efficient oil stripping equipment on the cold rolling mill to reduce rolling oil losses and oily waste	Oil stripping equipment installed and commissioned	✓ Successfully completed



»Aurubis Stolberg has continuously and successfully worked on integrating new environmentally compatible measures in infrastructure and production processes with its employees in the last several years. For example, the restoration of the company's sewer network continued, hydraulic groundwater protection was installed and the internal cooling circuit was modernized and equipped with state-of-the-art, energy-efficient technology. The Energy Management System pursuant to ISO 50001 installed in 2012 helps us to utilize energy more effectively and to record savings potential systematically with suitable measures.«

Dr. Jürgen Jestrabek, Plant Manager (left)
Martin Maiwald, Environmental Officer (right)

Environmental portrait of Aurubis Stolberg, Stolberg

Aurubis Stolberg has been part of the Aurubis Group since 2002 and supplies high-precision strip, foil and shaped wire for many different applications. Its customers include companies in the electrical engineering, electronics, automotive, construction, telecommunications and mechanical engineering industries. In the foundry, rolling mill and pressing and drawing mill, about 400 employees fabricate products made of copper and copper alloys for the global market.

Because of its geographic location close to the Vicht River, natural preserves and residential areas, it is crucial for Aurubis Stolberg to address environmentally relevant issues such as soil and water conservation as well as noise and immission protection consistently. By coordinating closely with the authorities, a working level has been

established that allows Aurubis Stolberg to implement innovative improvements effectively and efficiently. The new Energy Management System in accordance with ISO 50001 was developed and certified in cooperation with the TÜV (the German Technical Control Board) in the second quarter of 2012.

TÜV successfully carried out the first monitoring audit in 2013.

In the context of the Energy Management System, an energy-efficient production flow takes place with an optimized process chain and an improved equipment utilization plan.

www.aurubis.com/stolberg

Functional principle: installation of hydraulic groundwater protection in the area of the former roll stands

- » By using band skimmers in every restoration shaft, the oil phase floating on the groundwater is continuously absorbed and conducted to a container in the central shaft. Once the surface has been skimmed off, any remaining oil from the environment is drawn into the shafts by pumping the groundwater intermittently.
- » The oil-free groundwater in the shafts is conducted to a second container in the central shaft and is directed from there to the city's sewage system.
- » The facility is monitored remotely in addition to routine checks and inspections.

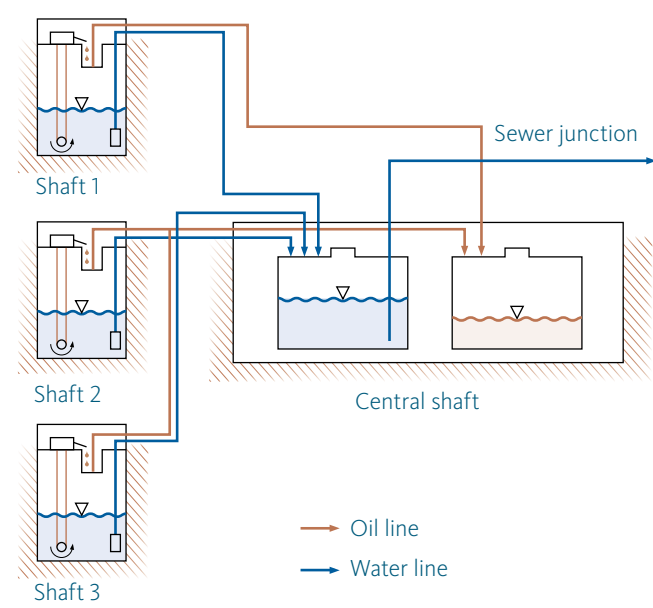

Aurubis Buffalo Inc.

located in Buffalo, USA

- » Producer of flat rolled products made of copper and brass for over 100 years
- » Certifications: ISO 9001, TS 16949
- » Business segment: Copper Products



 Copper and brass flat rolled products
108,800 t

Site size:
290,000 m²

Number of employees:
684

Central environmental targets and measures

Measure	Degree of implementation/Date/Next steps	Status
Resource efficiency: reducing sulfuric acid consumption by recovering it		
Installing facilities to clean used sulfuric acid		✓ Successfully completed
Switch from 98% sulfuric acid to a product that is more environmentally friendly	The project and trials are currently underway.	→ In progress
Reducing water consumption		
Analyzing water consumption in all the plants	The analysis is currently being carried out; building on this, the technical optimization solutions have been reviewed. An example of measures being used is the minimization of city water. This is accomplished by recirculating cooling tower water.	→ In progress
Expanding the recycling program at the site		
Products added to the site's existing recycling program: reels, cardboard cores, aerosol cans and filter paper	As many materials as possible are recycled. Additional materials will also be investigated for their recyclability in an ongoing process.	→ In progress

Buffalo site environmental portrait

Aurubis Buffalo, located in the state of New York, is about a half-hour away from Niagara Falls by car. Copper products have been fabricated here since 1906. The completely integrated plant with 696 employees includes a copper and brass foundry, a hot rolling mill and cold rolling mills, a number of annealing furnaces and a longitudinal slitting machine to produce strips with a variety of copper alloys, for example for connectors, telecommunications and electrical applications. In 2003 the plant became the first rolling mill for copper alloys in North America to earn TS 16949 certification, a quality management certificate based on ISO 9001. The investment program to modernize the plant is continually updated.

All of the foundry's off-gases are cleaned with filters before entering the atmosphere. The filter dust that accumulates in the process is recycled due to its zinc content. The acidic wastewater that results is neutralized in the wastewater treatment plant.

The Aurubis Buffalo site has been working jointly with the environmental team to increase education and awareness of chemical exposure, handling chemicals and managing waste produced at our facility. Chemical spill kits have been installed in areas where acid tanks are located. The kits contain flow charts reminding employees about working with chemicals as well as clean-up procedures, required personal protective equipment, contact numbers in case of a chemical release and how and who needs to clean up spills.



»Compliance with legal regulations, including environmental regulations, takes the highest priority for us. We also feel morally responsible for doing the right thing for our employees, the environment and our community.«

Ray Mercer, Plant Manager (left), Dr. Roberta Kloda, Senior Manager Safety and Environment (right)

We have developed an education program that all employees participate in, which includes executive management and hourly workers to ensure all employees at Aurubis Buffalo are aware of federal and state regulatory systems.

Beyond the central environmental targets, additional activities were carried out for the benefit of the employees and the environment during the reporting period. For example, the baghouse system and the oil mist collection system were optimized. Five water stations were installed in the plant where employees can fill their water bottles. Aurubis Buffalo set up three softball fields on company property, which can be used by the local softball league.

Schematic production process at the Buffalo site

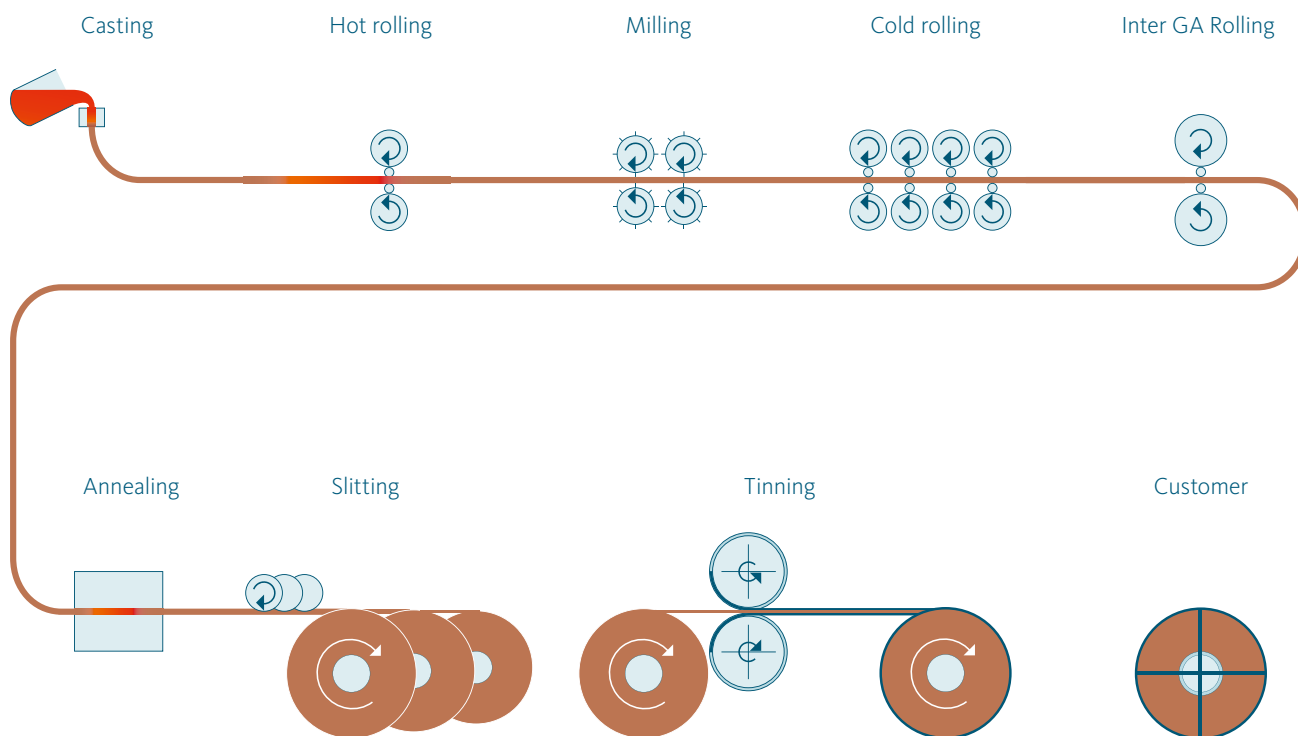

Aurubis Netherlands BV

located in Zutphen, Netherlands

- » Copper and brass strip producer
- » Certifications: ISO 14001, ISO 9001, TS 16949
- » Business segment: Copper Products



 Copper and brass strip
42,713 t

Site size:
90,000 m²

Number of employees:
320

Central environmental targets and measures

Measure	Degree of implementation/Date/Next steps	Status
Reducing water consumption		
Reusing water from the vaporizer that treats the tinning plant's wastewater	Implementation in 2011, optimization in 2012	✓ Successfully completed
Increasing energy efficiency		
Analyzing the possibility of increasing efficiency in compressor operations	Study started in 2011, completed in early 2014	✓ Successfully completed
Using waste heat from the annealing furnace by installing a heat exchanger	Implementation in late 2012	✓ Successfully completed
Soil remediation		
Soil remediation underneath transformers	Plan ready and approved, implementation to be finished by summer 2016	→ In progress
Soil remediation in the area of the vacuum filter	Implementation was finished by the end of 2014.	✓ Successfully completed
Renovation and certification of the impermeable floor of the outdoor sulfuric acid storage	Implementation started in 2014 and will be completed in 2015.	→ In progress

Zutphen site environmental portrait

Aurubis Netherlands BV in Zutphen produces copper and brass strip for the entire globe, mainly for the automotive industry but also for the connector industry. In 2014 42,713 t of strip were produced. Copper scrap is the main raw material used, supplemented with copper cathodes and zinc.

The plant is located in an industrial area with strict regulations. During 2013, machines from the sister company in Finspång, Sweden, were transferred to Zutphen. In line with the relocation, new personnel were also hired, for a current total of 320 employees. The new copper production line has been operational since the beginning of 2014. Furthermore, funds for environmental protection have been provided for the new line. An additional appendix to the existing environmental permit was granted for this project.



»In Zutphen we produce copper and copper alloy strip for the world market using a highly efficient continuous casting technology for strip as well as the high-quality supply of pre-rolled strip from the Aurubis Group. Protecting the environment and resources is very important for us. We value our relationship with the local government, which is characterized by transparency and cooperation, very much. They supported us in the transfer of the copper line from Sweden. Now we are taking action to integrate our partial permits into one integrated license to operate.«

Bernard de Jong, Manager for Safety, Health, Environmental and Quality (left)
Thomas Sturm, Plant Manager (right)

In 2014 Zutphen started with the renewal of the current environmental permit for the entire site. This permit will cover all demands from the local authorities and the water authority (Rijkswaterstaat) for the whole plant.

One of the environmentally friendly processes in Zutphen is direct strip casting. This unique casting technology is highly efficient because it allows Aurubis Netherlands to eliminate one of the energy-intensive steps. A great deal of energy is saved because the material isn't cooled and melted again after casting, which would normally be the case.

Water use

- » Over the past few years, Aurubis Netherlands has been able to reduce the total quantity of water consumption thanks to the reuse of water from the vaporizer that treats the tinning plant's wastewater (see table of targets and measures).
- » The slight increase in water consumption in 2014 is a result of the additional copper production which started in October 2013.

Water use in 1,000 m³

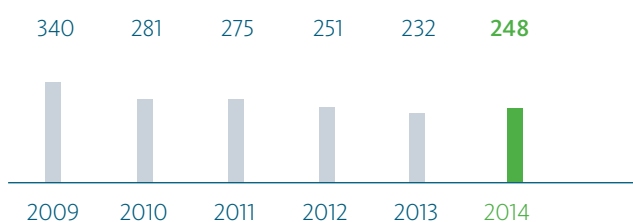

Production waste: recycling and disposal

- » Generated production waste is recycled for the most part.
- » The increase in production waste results from a rise in total production.

Production waste in t in 2014

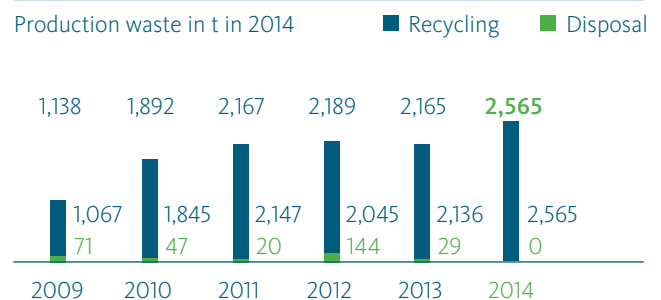

Aurubis Finland Oy

located in Pori, Finland

- » Producer of copper strip, sheet, plate and circles as well as billets and cakes
- » Certifications: ISO 14001, ISO 9001, OHSAS 18001¹
- » Business segment: Copper Products



 Copper strip, sheet, plate and circles
28,111 t

 Copper shapes
46,906 t

Site size:
78,070 m²

Number of employees:
200

Central environmental targets and measures

Measure	Degree of implementation/Date/Next steps	Status
Reducing emissions to air		
Emission measurements for the shaft furnace's different modes of operation	Measurements completed in late 2012; a decision was made to continue with the closed shaft furnace and afterburning of exhaust gases.	✓ Successfully completed
Developing an implementation concept to optimize off-gas cleaning	Implementation concept developed in September 2013. The filter house usage increased from 92 % to 97%.	✓ Successfully completed
Further optimization of off-gas cleaning by increasing filter house usage by at least 98 %	Development to be completed at the end of 2016	→ In progress
Reducing energy consumption in the foundry		
Developing a new cover for the casting launder to lower heat losses, thus enabling a reduction in the number of burners. Integrating the temperature control in the process control system. The plan is to cut energy consumption in the casting process by more than half.	A cover was installed on the casting launder in August 2012. The decrease in butane consumption was 1.3 kg/t from 2012 to 2013.	✓ Successfully completed
Cutting energy consumption in the afterburner during casting by more than half. A VOC analyzer will show whether afterburning of the off-gases is required → Minimizes CO ₂ emissions	The VOC analyzer has been tested since January 2015 and will be commissioned starting in summer 2015.	→ In progress
Improved soil protection in the unroofed storage areas		
Cleaning, installing a wall and sealing the non-roofed storage area in the scrap storage yard to prevent rain-water in unsealed areas	Finished in September 2012	✓ Successfully completed
Better waste management		
Improvement in waste logistics by avoiding unnecessary transportation of waste and improving communication with subcontractors	Summer 2013	✓ Successfully completed
Decrease in waste volume	Citric acid has not been used in one of the annealing lines since September 2013.	✓ Successfully completed

¹Occupational Health and Safety Assessment Series, a standard for occupational health and safety management systems



»At Aurubis Finland Oy, we see ourselves as part of society and assume the environmental responsibility that comes along with this role. Our central concern is continuously finding new ways to lower energy and resource consumption and emissions. We have considerably reduced the dust emissions at our site and the target is to maintain this success and continue improving it. Our current capital expenditure for environmental protection aims to reduce energy consumption and copper emissions. We have successfully optimized our waste management system, which has reached the excellent recycling rate of more than 98%.«

Minna Eerola, Environmental Officer (left)
Hannu Heiskanen, Plant Manager (right)

Pori site environmental portrait

The Aurubis Finland production site is located in Western Finland in Pori on the Kokemäenjoki River. The copper foundry and rolling mill are in a copper industrial park where other companies working with copper are located. The area of the site is about 78,000 m².

The rolling mill in Pori is a state-of-the-art hot and cold rolling mill, and it is fully integrated from casting to finishing. In 2014 our 200 employees produced 28,111 t of strip, sheet, plate and circles as well as 46,906 t of shapes, some of which were for internal use.

The selection of high-quality products covers a wide range of copper and copper alloys. Copper scrap is used first and foremost for production; recycling materials account for around 75% of the raw materials used in the foundry. The waste heat that arises in the foundry is sold to the local power plant Pori Energia. The waste heat produced during the hot rolling process is reused to pre-heat combustion air during processing. Emissions of dust and volatile organic compounds (VOCs) are reduced to a minimum using afterburning and filters.

Cooling water in the smelting process circulates in a closed system. Cooling water and some process water from the rolling mill are treated; copper and oil residues are separated. In the past three years, more than € 660,000 has been invested in measures that improve environmental performance.

Dust emissions*

» The optimization of off-gas cleaning in the shaft furnace is already having positive impacts. Dust emissions have significantly decreased compared to previous years.

* Dust emissions mainly arise from the foundry, so this figure represents the entire site's emissions.

Dust emissions in g/t of copper products sold

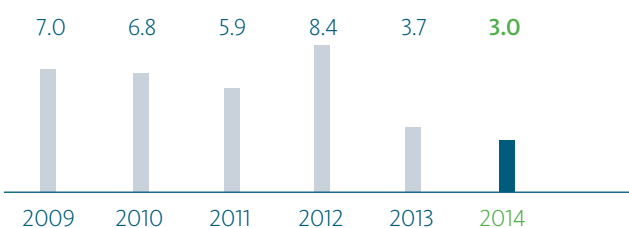

Total quantity of waste: recycling and disposal

» Production waste is almost completely recycled – the recycling rate was 98% in 2013.

Production waste in t in 2013

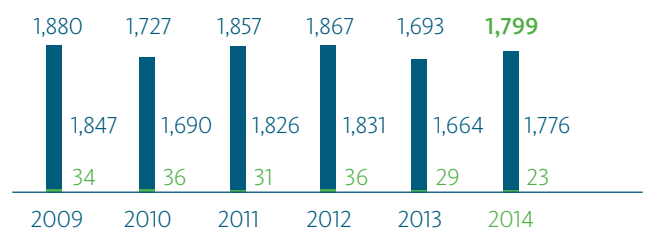

Aurubis Italia Srl

located in Avellino, Italy

- » The only copper rod producer in Southern Italy
- » Certifications: ISO 14001, ISO 9001
- » Business segment: Copper Products



Continuous cast rod
153,816 t

Wire
3,270 t

Site size:
58,000 m²

Number of employees:
107

Central environmental targets and measures

Measure	Degree of implementation/Date/Next steps	Status
Energy efficiency and climate protection		
New electricity meters for monitoring production and waste treatment plants	Installation completed in August 2014	✓ Successfully completed
Installing a new inverter drive on the fan of the shaft furnace fume treatment plant	August 2015	→ In progress
Reducing water consumption		
A new well will be installed to decrease the specific consumption of water	August 2015	→ In progress
Air emissions		
Installing a new plant for additive injection on shaft furnace fume treatment plant	Completed in September 2014	✓ Successfully completed
Reducing fugitive emissions of volatile organic carbon from the rolling mill	Finished in June 2014; 75 % reduction in emulsion consumption	✓ Successfully completed
Waste and recycling		
Installing a filter press on the process water treatment plant in order to reduce the amount of disposed hazardous waste	Feasibility study has started; scheduled to be completed in 2016	→ In progress
Waste check-up and new global service for collection, transport and waste disposal	March 2014	✓ Successfully completed
Environmental management		
Implementing a new integrated manual for health, safety and environmental management system according to ISO 14001 and BS OHSAS 18001 standards as a new tool to improve sustainability and environmental protection	May 2015	✓ Successfully completed
Improving internal audit with external consultant	Ongoing	→ In progress

Avellino site environmental portrait

Aurubis Italia is located in Avellino and is the only copper rod producer in Southern Italy. In 2013 a total of 107 employees produced 138,000 t of rod and 2,700 t of wire for special applications. Aurubis Italia has been under an IPPC permit since 2009 (IPPC refers to the EU

Directive on Integrated Pollution Prevention and Control). The high efficiency of Aurubis Italia's production lines enables nearly 100 % of the raw materials used to be processed into products. Modern cleaning and filter facilities keep off-gas and wastewater to a minimum.



»Our commitment to environmental issues is embedded in our company's culture and represents a daily guidance for our working life. We are constantly looking for more ambitious sustainability targets, always beyond the existing requirements, in order to remain as reference in our location and worldwide in the non-ferrous industry. The ongoing improvement of our performances in environmental protection makes us proud and stimulates further efforts.«

Antonio de Blasio, Plant Manager (left)
Gianpaolo Antonacci, Environmental Officer (right)

Wastewater is continuously monitored before entering the sewer system thanks to an automatic water sampling system. A new service started for cleaning roads and yards at the Avellino site with a street sweeper, which has reduced the metal load in the water discharge. Exhausted emulsion generated from the rolling mill has been reduced with a vacuum vaporizer.

Volatile organic compounds (VOCs) from the rolling mill were significantly reduced by lowering the amount of isopropyl alcohol by 75%. The VOCs are collected and treated with a scrubber system. The fugitive emissions

in the smelting area were considerably lowered due to a vacuum system and hoods on the launders and holding furnace. Many small energy-saving initiatives were implemented during the last few years thanks to continuous improvements in the production process. Specific energy consumption and CO₂ emissions have decreased by about 10% during the past five years. In the last several years – as a result of lower energy consumption – Aurubis Italia has reduced about 20% of the energy costs, which account for a large part of the operating costs for environmental protection.

Dust emissions

» The emissions to air were reduced significantly as a result of implemented projects. The dust emissions decreased by more than 30% due to the installation of a new plant for the injection of special additives (phyllosilicates in baghouse filters) in the existing treatment of the shaft furnace flue gas system.

Dust emissions in g/t of rod output

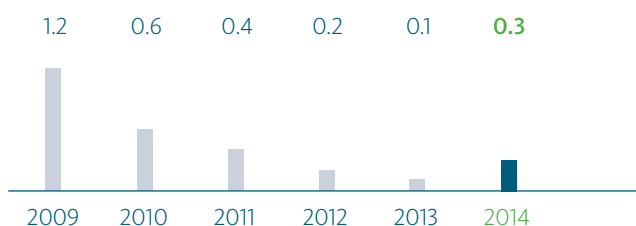

Disposal and recycling of production waste

» The total amount of waste produced in the last two years decreased by more than 50%, and 80% of the total hazardous and non-hazardous waste was recoverable.

Production waste in t

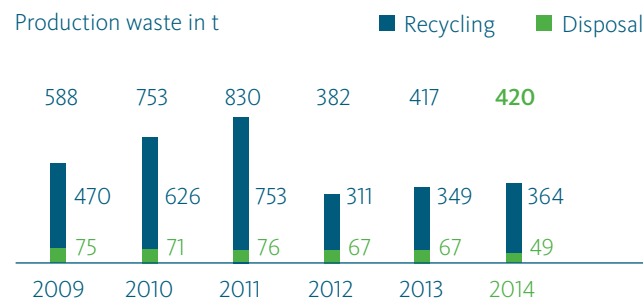

Deutsche Giessdraht GmbH

located in Emmerich on the Rhine, Germany

- » Specialist in producing continuous cast rod for special applications
- » Certifications: ISO 14001, ISO 9001, ISO 50001
- » Business segment: Copper Products



Group total:
6,503

 Rod
248,400 t

Site size:
32,000 m²

Number of employees:
118

Central environmental targets and measures

Measure	Degree of implementation/Date/Next steps	Status
Reducing specific electricity and natural gas consumption		
Reducing electricity consumption by modernizing the lighting	Large segments of the outdoor and indoor lighting were switched to LED technology in 2012 and 2013.	✓ Successfully completed
Decreasing electricity demand for the tankhouse	Copper loss in the pickling line and therefore the electricity demand in the tankhouse for copper recovery was reduced by optimized cooling of the rod.	✓ Successfully completed
Switching coil packaging to stretch wrap	The existing coil packaging machine based on shrink-wrap was replaced with a new machine using stretch wrap. This saves natural gas and uses less wrapping material. The project was completed in August 2014.	✓ Successfully completed
Wastewater treatment		
Replacement of exchanger resin in a wastewater treatment facility	Renovation of the resin beds in the production-integrated decopperization installation for rod cooling water	✓ Successfully completed
Hardware and software upgrade for the measurement and control technology of the production-integrated decopperizing facility for the wire cooling water	Replacing the control hardware and updating the control program in connection with a digital process visualization using a touch panel	→ In progress
Reducing emissions to air		
Changing the filter sleeve in an off-gas cleaning facility	Replacement of the complete filter sleeve set in the dedusting installation for the shaft furnace off-gas	✓ Successfully completed
Energy efficiency and climate protection: cathode transport by rail		
Relocating transport services from roads to railways	More cathode transports between Lünen and Emmerich have been moved to the railways since early 2011, reducing CO ₂ emissions, noise and road traffic.	✓ Successfully completed

Emmerich am Rhein site environmental portrait

Deutsche Giessdraht GmbH is a 60% Aurubis subsidiary that produces high-quality continuous cast copper rod. The company, which was founded in 1975, is in Emmerich on the Rhine with optimal connections to shipping and the roadway and railway network. The company's 118 employees produce up to 300,000 t of rod annually.

The production process consists of melting, casting, rolling, pickling and coiling the copper.

The rod production facilities are state-of-the-art from a technical standpoint and fulfill all product quality and environmental protection standards. Specific energy consumption – primarily natural gas and electricity are



»We have modernized our plant continuously in the past several years within the scope of various investment projects. Today, DG is a leader in energy efficiency when compared with other rod plants worldwide. Our Energy Management System pursuant to ISO 50001, which was introduced in 2012, is a valuable tool to maintain the level we have achieved and continue improving it. Consistent waste avoidance and the search for new recycling options have further improved our waste balance. This will allow us to fulfill our ecological and economic responsibility completely in the future.«

Dr. Stefan Schneider, Plant Manager (left)
Richard Hoch, Environmental Officer (right)

used – has been reduced little by little in the last several years thanks to continuous improvements in the production process.

About 1,100 t of waste are generated each year during production. In 2014, roughly 43% of this amount was copper-bearing materials that were recycled at Aurubis AG's Lünen site. Deutsche Giessdraht GmbH's waste management is so efficient that more than 99% of the waste can be recycled.

The certification of the Environmental Management System in accordance with ISO 14001 was confirmed again in June 2015 and is valid until 2018. In addition, the Energy Management System pursuant to ISO 50001 was introduced in 2012 and the site was certified in accordance with this standard.

Water consumption

» Water is mainly used for cooling purposes. Cooling water withdrawal is constantly adjusted to current consumption. Specific water consumption has fallen sustainably by about 20% due to the start-up of pumps with a variable rotational speed in 2007.

Water consumption in m³/t of rod output

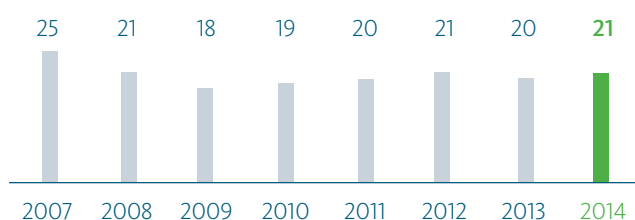

Specific energy consumption

» Electricity is primarily used in the rolling mill but also in the drives for pumps, compressors, fans, lighting etc. Extensive component modernization and the strict use of energy-efficient drive systems have led to a decrease in specific electricity consumption from 66 to around 60 kWh/t of rod output since 2009.

Specific electricity consumption in kWh/t of rod output

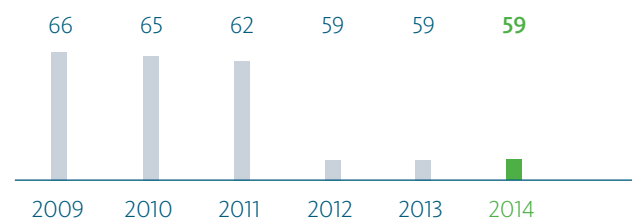



CABLO Metall-Recycling & Handel GmbH

located in Fehrbellin and Strass, Germany

- » Specialist in cable recycling
- » Certifications: ISO 14001, ISO 9001, ISO 50001, Waste Management Company
- » Business segment: Recycling/Precious Metals

Group total:
6,503

 Copper products 14,500 t
  Plastic products 5,600 t
  Aluminum products 1,900 t
  Other non-ferrous metals 430 t

Site size:
45,500 m²

Number of employees:
59

Central environmental targets and measures

Measure	Degree of implementation/Date/Next steps	Status
Increasing energy efficiency in electricity consumption by 1.5% annually		
Substituting large drives with high-efficiency electric motors in relevant facilities	Already carried out: test replacement of a 55 kW drive and evaluation of the data. The drives are currently being selected. The motor replacement is planned as follows: » completed for > 50 kW » fall 2016 for > 20 kW » fall 2017 for < 20 kW	→ In progress
Assessing the effect of the qualitative and quantitative composition of the cable waste on the dismantling facilities	Planning the data collection process. Carrying out recordings and concluding the evaluation by summer 2015	→ In progress
Substituting an old diesel forklift with a new, energy-efficient diesel forklift	Planned for summer 2015	→ In progress
Energy efficiency: optimizing environmental protection procedures		
Electronically recording the individual facilities' energy consumption	Fehrbellin: already implemented, expansion necessary to optimize the operating process; Strass: implementation to start after permit is issued	→ In progress
Modernizing water pollution control facilities		
Restoring the rainwater drainage at the Strass site	Implementation will start when the permit has been issued	→ In progress
Reducing fugitive dust emissions at the Strass site		
New mobile suction system on the cable slitting machines at the Strass site	The suction system has been delivered and will be installed in the summer.	→ In progress



»Now that the organizational standards for the management system have been successfully introduced and confirmed in a second audit, we can now point to many activities for the improvement of our energy and environmental performance, an area in which we have already reaped initial results. We have gained a detailed overview of our energy-related facilities with a systematic data analysis and can now push the planning forward in a structured manner. The quality of the continuous improvement process at CABLO has increased, which was confirmed in the audits carried out by our certifying company. We're pleased to be able to make a significant contribution to climate protection as part of the Aurubis Group.«

Daniel Hoffmann, Environmental Officer (left)
Dr. Michael Liesegang, Plant Manager (right)

Fehrbellin and Strass site environmental portraits

CABLO Metall-Recycling und Handel GmbH (CABLO) is a 100% Aurubis Group subsidiary specializing in metal-plastic separation. Cable product waste and used cable scrap are recycled at the two sites in Fehrbellin and Strass. By separating metals and plastic, CABLO provides the Group with the recovered raw materials in a usable form such as copper cathodes, copper wire rod and conductive aluminum.

CABLO produces hardly any emissions due to the purely mechanical work processes. The focuses of the environ-

mental work are therefore on enhancing energy efficiency and increasing material recovery rates.

The existing Quality Management System in accordance with ISO 9001 was expanded to include an Environmental and Energy Management System pursuant to ISO 14001 and ISO 50001. The Integrated Management System was certified for the first time in 2012. Occupational safety and health protection have always been part of the management system in practice – more than 1,250 days without an accident as of the end of 2014 prove this.

Dust emissions

- » In dismantling facilities, the cable insulation is separated from the metal core with cutting and grinding processes. The facilities' exhaust air is completely suctioned off and filtered before being discharged into the ambient air.
- » The strong decrease in emissions, especially in 2010, is due to new recordings which prove the success of the emission reduction measures carried out in the past several years.

Dust emissions in g/t of metal output

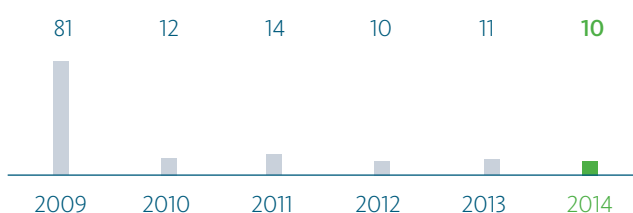

Plastic waste recycling

- » In the internal recycling process, PVC-bearing mill feed is processed into standardized products for the transport sector, for example base plates for delineator posts. In addition to internal mill feed, residues from other companies are also recycled.
- » After dismantling the cable, non-PVC-bearing plastic and residual waste is directed to an external recycling or disposal company. The recycling rate was over 99% in 2014.

PVC-bearing plastic waste in t

- from other companies
- from internal cable dismantling

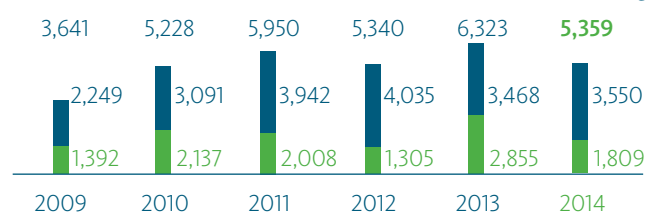

Elektro-Recycling NORD GmbH

located in Hamburg, Germany

- » Specialist in recycling electrical and electronic devices
- » Certifications: ISO 14001, ISO 9001, Waste Management Company
- » Business segment: Recycling/Precious Metals

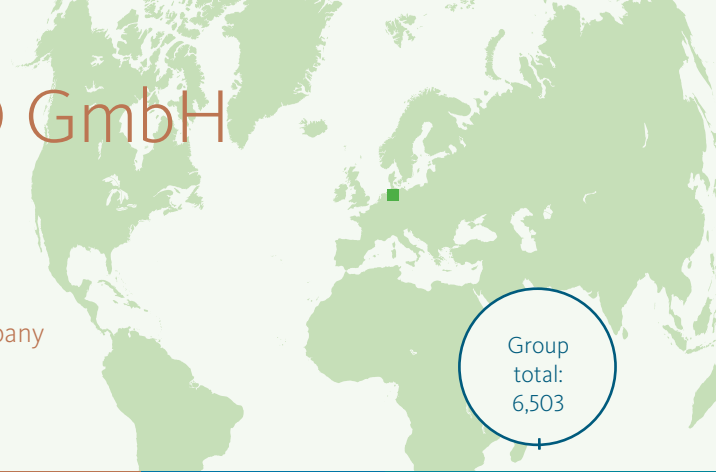

Group total:
6,503

 Electrical and electronic scrap
15,000 t

Site size:
6,400 m²

Number of employees:
14

Central environmental targets and measures

Measure	Degree of implementation/Date/Next steps	Status
Increased energy efficiency in the electronic scrap shredder		
Renovation of the material feed conveyor in connection with the installation of a digital display to indicate the rotor resistance. The continuous feed reduces CO ₂ emissions by about 14%.	Normal operation began in 2013.	✓ Successfully completed
Protecting employees from hazardous materials and noise		
Voluntary hazardous substance recordings in the manual dismantling area, taking the Technical Rules for Hazardous Substances into account	Carried out in 2013; the process was positive. The recordings were repeated in 2014.	✓ Successfully completed
Emission recordings in the cable dismantling plant and another dismantling facility in accordance with the German Federal Immissions Act (BImSchG)	Carried out in 2014 at regular intervals	→ Ongoing
Noise reduction program with sound insulation mats in the electronic scrap dismantling facility	Noise reduction is an ongoing process for all of the facilities. Noise pollution was reduced by about 50% in the electronic scrap dismantling facility in 2013.	→ Ongoing
Reducing fugitive dust emissions		
Renovating the feed conveyor in the electronic scrap dismantling facility with an additional collection box for dusts and fine particles. Reducing fugitive dusts by about 70%	Completed in 2013	✓ Successfully completed
Constructing stone partition walls in all outdoor storage areas	First part of project in 2011, second phase completed in 2012	✓ Successfully completed
Reducing energy for lighting		
Recording the lighting in connection with a program to save energy	Since 2013 recording of all light fixtures and calculation of the power per facility or department, possibly replacing the fixtures with LED lights afterwards. The measure is scheduled to be completed in late 2016.	→ In progress



»The environmental compatibility of our own economic activities holds the highest priority – we are committed to this. We make raw materials from electrical and electronic scrap and return them to the material cycle. We view saving energy and resources as our responsibility under the aspect of resource conservation, adhering to the guiding principle of sustainable and future-oriented development.«

Lothar Broszio, Plant Manager (left)
Norbert Barth, Environmental Officer (right)

Environmental portrait of E.R.N., Hamburg

Elektro-Recycling NORD (E.R.N.) is a 100% Aurubis subsidiary that specializes in recycling all kinds of electrical and electronic devices. The extensive service-oriented solutions for waste issues guarantee conformity with the provisions of waste and recycling management law. The company's customers include large international firms, small enterprises and private individuals.

E.R.N. is a member of the Quality Association for Electronic Scrap in the Federation of German Metal Traders and follows the principles of comprehensive resource recycling. E.R.N. makes raw materials out of scrap,

returning the valuable substances to the material cycle in an environmentally conscious manner. E.R.N.'s service catalogue consists of disassembling, recycling and disposing of all kinds of electrical and electronic devices as well as industrial products. Picking up individual devices and components and dismantling installations are also included in the services.

In 2013 the material feed conveyor was renovated and a digital display was installed to indicate the rotor resistance. This measure has already been successful: the continuous feed reduces CO₂ emissions by about 14%.

Recycling at E.R.N.

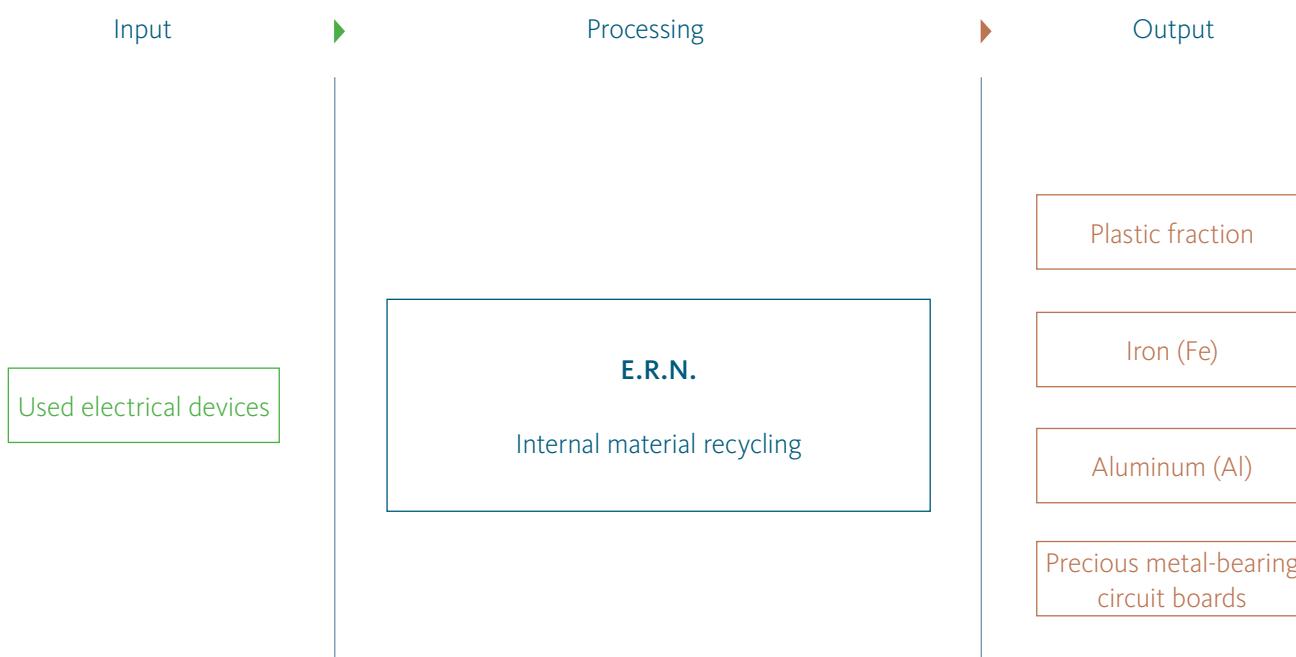

RETORTE GmbH, Selenium Chemicals and Metals

located in Röthenbach, Germany

- » Produces selenium products for the glass, solar and animal feed industries
- » Certifications: ISO 9001
- » Business segment: Primary Copper



Mineral premixtures
1,600 t

Selenium products
790 t

Site size:
13,000 m²

Number of employees:
41

Central environmental targets and measures

Measure	Degree of implementation/Date/Next steps	Status
Using raw materials more effectively		
Improving selenium recovery in the wastewater collection equipment	Planning phase. Before the measure is carried out, renovations to the wastewater system can be expected as part of a current licensing procedure under water management law. To be implemented by mid-2015.	→ In progress
Reducing the discharge of selenium into the wastewater system with measures in the work organization	To be implemented by late 2014	✓ Successfully completed
Saving energy and improving air pollution control		
Optimizing the oxygen dosage on the oxidizers	Brainstorming phase until late 2014, new nozzles were purchased for trials, installation and test in spring 2015	→ In progress
Adding a heat recovery unit to the new air inlet and outlet facility	A technically and economically feasible solution wasn't found in the brainstorming phase.	Project will not be pursued further
Saving water		
Developing a concept for using process water multiple times	Brainstorming phase. The concept should be developed by mid-2015.	→ In progress
Optimizing the dosage of chemicals for wastewater treatment	The study phase ended in late 2014. Chemical use decreased significantly.	✓ Successfully completed
Optimizing waste and recycling		
Study on improved activated charcoal treatment for raw acids	Study phase scheduled for completion by mid-2015	→ In progress

Röthenbach site environmental portrait

RETORTE GmbH, a small specialized company, serves global markets in the glass, feed, solar and pharmaceutical industries with high-quality selenium products such as pure selenium, selenium alloys, sodium selenite and trace element premixtures. A large proportion of the raw selenium produced worldwide is processed at our site in Röthenbach, about 10 km east of Nuremberg.

Concentrating a rare and toxic trace element to that extent in one location entails a high level of responsibility for protecting the environment from any detrimental effects of our industrial activities.



»Processing large quantities of a rare trace element poses a special challenge. There are no ready-made solutions and many of the processes are unique to our site. This means that we are always entering new territory when it comes to making progress.«

Christoph Imkamp, Plant Manager (left)
Grit Monse, Environmental Officer (right)

We keep emissions of all kinds to a minimum and secure a high standard of production safety with a variety of measures. Furthermore, aspects of sustainable and resource-efficient process design are also a key focus. With intelligently linked cycles, we are able to utilize our valuable raw material, selenium, in the best possible way and to reintegrate by-products in the production process.

Improving environmental protection is an ongoing responsibility for RETORTE. Adherence to stricter wastewater standards requires an even better understanding of the processes as well as good ideas – a challenge that the team is happy to take on for everyone’s benefit.

www.retorte.de/english

Production at RETORTE

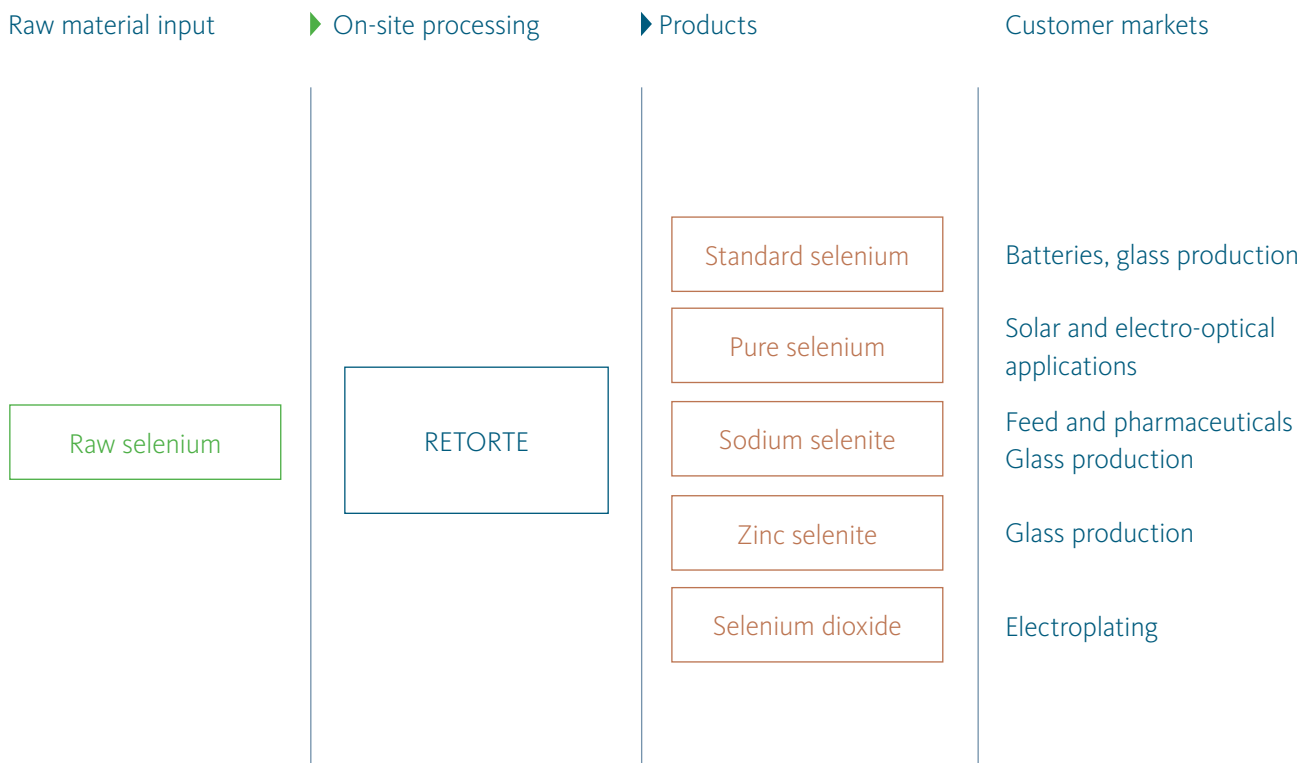

Peute Baustoff GmbH

located in Hamburg, Germany

- » German market leader in the iron silicate products sector
- » Iron silicate products are registered with REACH for all intended applications
- » Certifications: ISO 9001 for the sale of iron silicate granules for blasting abrasive production
- » Business segment: Primary Copper



Group total:
6,503

 Iron silicate stone
453,000 t

 Iron silicate granules
296,000 t

Site size:
68,000 m²

Number of employees:
12

Central environmental targets and measures

Measure	Degree of implementation/Date/Next steps	Status
Reducing emissions to air		
Enlarging the dust removal facility; optimizing the suction points	In fall 2013 the filter in the crushing/screening plant was renovated and commissioned. The pipelines and suction hoods were optimized at the same time.	✓ Successfully completed
Optimizing the existing overhead sprinkler system	Initial organizational measures were carried out. Concept development and implementation are scheduled for fiscal year 2015/16.	→ In progress
Reducing emissions to water		
Optimizing surface drainage	The initial concept for organizational improvements was developed in 2012 and implemented in 2013.	✓ Successfully completed

Environmental portrait of Peute Baustoff, Hamburg

Peute Baustoff GmbH (PBG) is a 100 % Aurubis AG subsidiary. It emerged from the construction materials department in 1992 and is responsible for marketing the iron silicate products produced at Aurubis in Hamburg. These are recovered in the course of copper production in two forms with consistent material properties in accordance with the DIN 4301 standard: as crystalline iron silicate stone and amorphous iron silicate granules.

After being processed in a crushing/screening plant, iron silicate stone is used in different grain sizes and weight classes in hydraulic engineering, road construction and as a stone additive in concrete. Iron silicate granules are

used as a blasting abrasive in cement production under the brand name NAstra®. The iron silicate products fulfill the requirements of the relevant national and international regulations for the different applications, e.g. EN ISO standards and technical delivery conditions. PBG is committed to its environmental responsibility. Its operations are authorized pursuant to the German Federal Immissions Act (BImSchG) and are subject to monitoring accordingly. The use of dust removal equipment and overhead sprinklers as well as sweepers to reduce dust ensures that the applicable environmental provisions are observed.

www.peute.de



»Each cubic meter of iron silicate stone prevents about 1.4 m³ of rock from being quarried and thus conserves natural, non-renewable resources. The use of iron silicate stone therefore makes an important contribution to sustaining existing raw materials. We also support environmental protection with our new filter, which considerably reduces dust emissions from the production plant. The suction output can be adjusted to current demand with the frequency-controlled drive. Only the energy required for effective environmental protection is used.«

Marc Waltemathe, Plant Manager (left)
Thomas Zantz, Environmental Officer (right)

Dust emissions

in g/t of processed iron silicate stone

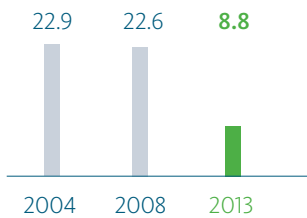

» New measures that have already been implemented, such as sprinkler systems and surface sweeping, have been successful: dust emissions per ton of processed iron silicate stone have been reduced by over 60% since 2004.

The values are calculated as part of the emissions declaration, which isn't issued annually.

Product lifecycle of iron silicate stone: from formation to use as armorstone

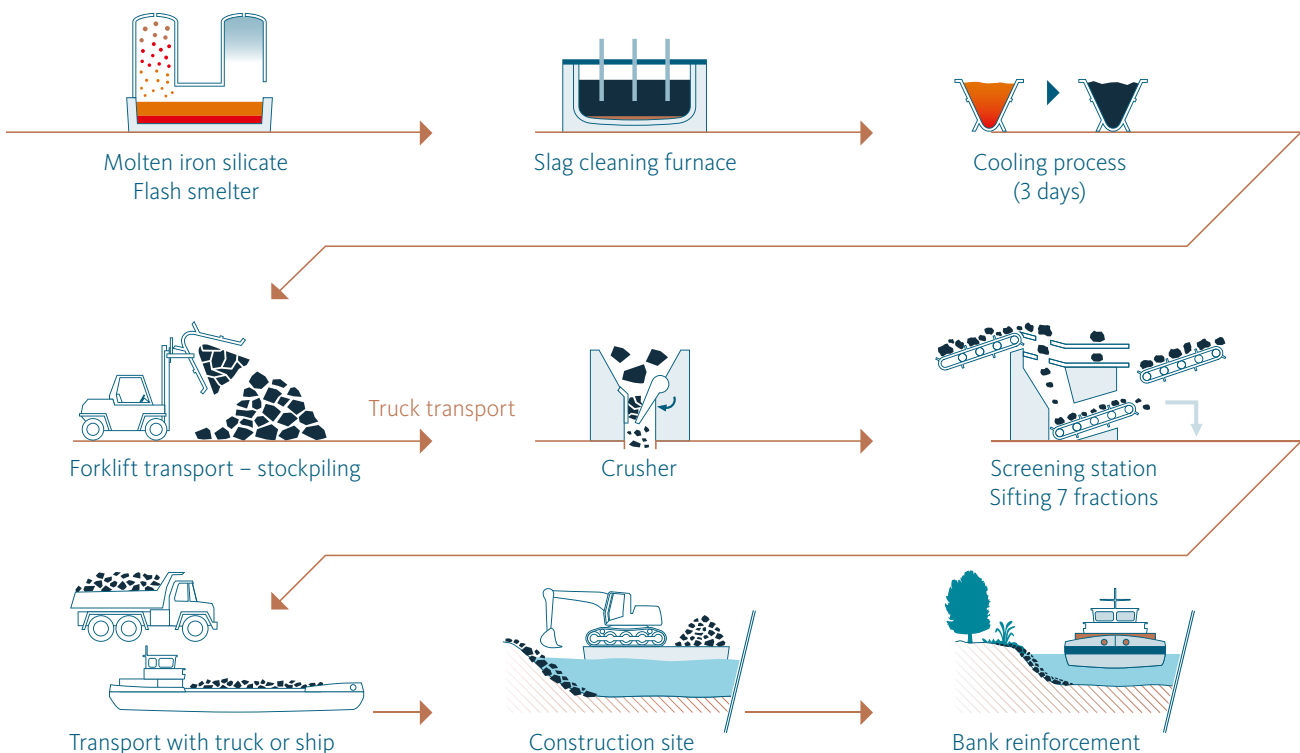

Glossary

Anode slimes

A product of the copper tankhouse which settles at the bottom of a tankhouse cell. Contains precious and non-soluble components of the anode, including silver, gold, selenium and lead in particular.

BAT

“Best available techniques”. See also Sevilla Process

Circular economy

In a circular economy, the raw materials utilized are completely returned to the production process after a product's lifecycle.

CLP Regulation

Regulation (EC) No. 1272/2008 on the classification, labeling and packaging of substances and mixtures, which went into effect on January 20, 2009, introduced a new system for classifying hazardous chemicals and implemented the United Nations' “Globally Harmonized System” (GHS) in Europe.

Copper cathode

Quality product of the copper tankhouse (copper content 99.99%) and first product of copper fabrication that can be sold on the exchanges

Copper concentrates

A product resulting from processing (enriching) copper ores, Aurubis' main raw material. Since copper is almost always chemically bonded and occurs in small concentrations in ores (0.5% to 4% copper content), the ores are enriched into concentrates (copper content 25% to 40%) in processing plants after being mined.

EfB (Entsorgungsbetrieb)

German certification for waste management companies

EMAS

The acronym stands for Eco-Management and Audit Scheme, a system for environmental management and eco-auditing for organizations. EMAS was developed by the European Union. Participating organizations must publish an environmental declaration in which they describe their influence on the environment, their environmental performance and their environmental goals, among other things. This is reviewed by an independent environmental consultant and must be updated every year. At least every three years the consultant assesses the Environmental Management System, compliance with environmental policy, compliance with legal provisions and the consolidated environmental declaration.

EU Emission Trading System

The European Union Emission Trading System (EU ETS) limits CO₂ emissions within the EU, where companies are allocated emission rights in the form of tradable certificates.

Flash smelter

The first step of the pyrometallurgical process in copper concentrate processing takes place in the flash smelter. Concentrate falling (floating) in a reaction shaft reacts with oxygen. The concentrate melts due to the released heat. Sulfur and iron are separated as intermediate products. The copper in copper matte is enriched to about 65% copper content.

Fugitive emissions

Fugitive emissions are emitted by undirected emission sources (e.g. from storage areas). In contrast, “collected emissions” are emitted by directed emission sources (e.g. smokestacks).

Iron silicate stone

A solidified by-product of the copper smelting process. During the process the iron contained in the copper concentrate and recycling raw materials is combined with silicate flux (SiO_2) to yield iron silicate ($2 \text{FeO} \times \text{SiO}_2$). Although its structure is similar to natural rock, this artificially produced stone has a substantially higher density and weathering resistance. It is used as granules/sand or in a lumpy form, especially in the construction industry.

ISO 9001

This standard describes the requirements of a quality management system. It is process-oriented and contains basic principles for structured procedures and measures within a company. Its objective is the ongoing improvement of internal processes, helping the company to ensure and increase customer satisfaction.

ISO 14001

This global standard provides the criteria for establishing and auditing the environmental management of a company. If the external auditor confirms the adherence to the criteria, the company receives a certificate which is proof of a functioning Environmental Management System.

ISO 50001

Global standard for energy management systems

Kayser Recycling System (KRS)

A state-of-the-art recycling system used to process a wide range of copper-bearing secondary raw materials at the Lünen site

LME (London Metal Exchange)

The most important metal exchange in the world with the highest turnover

Metallurgy

Refers to all processes for extracting and using metals as well as metallurgically relevant semimetals and non-metals from ores, soils, salts and secondary raw materials

REACH

REACH stands for “Registration, Evaluation, Authorization and Restriction of Chemicals”. The REACH directive went into force in the European Union on June 1, 2007. The objective of the directive is to collect information on all of the material streams in the EU in order to improve protection of people and the environment.

Selenium

A semi-metal in Group 6 that is closely related to sulfur. It is finely distributed all over the earth and is mainly found in sulfidic ores. Copper ores contain between 0 and 20 ppm of selenium. Selenium follows the same path as precious metals in copper reprocessing and is separated from the anode slimes as raw selenium. Although selenium is an essential trace element vital for health, it is highly toxic in large amounts.

Sevilla Process

The exchange regarding the establishment of best available techniques is referred to as the Sevilla Process because the European office organizing it is located in Sevilla (European Integrated Pollution Prevention and Control Bureau – EIPPCB).

Stakeholders

All of the internal and external groups of people who are directly or indirectly affected by a company's activities in the present or future. A company's stakeholders therefore include employees, suppliers and customers, but also NGOs, academic organizations, governments, etc.

Sulfuric acid (H₂SO₄)

A strong acid used by the chemical industry as a basis for numerous products and processes. Sulfuric acid is produced at Aurubis as a by-product of primary copper production. The sulfur dioxide (SO₂) occurring during concentrate processing is oxidized further into SO₃ by adding oxygen in a catalyzed reaction and is then dissolved in water, which results in sulfuric acid.

TS 16949

This standard combines existing general provisions for the automotive industry's quality management systems. It was developed by members of the International Automotive Task Force and published together with the International Organization for Standardization (ISO) as a Technical Specification (TS) based on EN ISO 9001.

TÜV

Technical Control Board: a German certification authority that carries out technical safety checks, in particular those that are required by laws or state regulations.

VOCs

Volatile organic compounds

WEEE Directive

EU Directive 2002/96/EC, Waste Electrical and Electronic Equipment Directive

Contact information and imprint

Your contacts at Aurubis AG

Corporate Environmental Protection

Dr. Karin Hinrichs-Petersen

Head of Corporate Environmental Protection
Phone +49 40 7883-3609
k.hinrichs-petersen@aurubis.com

Orhan Cekel

Head of Corporate Technical Environmental Protection
Immission Protection Officer
Phone +49 40 7883-3921
o.cekel@aurubis.com

Daniela Cholakova

Corporate Environmental Manager
Phone +32 2227-1219
d.cholakova@aurubis.com

Jan Drzymalla

Corporate Environmental Coordinator
Phone +49 40 7883-3663
j.drzymalla@aurubis.com

Dr. Jörn Mühlenfeld

Corporate Environmental Manager
Phone +49 40 7883-3663
j.muehlenfeld@aurubis.com

Corporate Communications

Michaela Hessling

Head of Corporate Communications
Phone +49 40 7883-3035
m.hessling@aurubis.com

Matthias Trott

Senior Communications Manager
Phone +49 40 7883-3037
m.trott@aurubis.com

Kirsten Kück

Sustainability Manager
Phone +49 40 7883-3270
k.kueck@aurubis.com

Publisher

Aurubis AG, Hovestrassse 50
20539 Hamburg
Phone +49 40 7883-0
Fax +49 40 7883-2255
www.aurubis.com

English translation

Sara Broberg

Concept

Ulrike Ahrens, Sustainability Services

Design

domin kommunikationsdesign

Lithography

CLX EUROPE Media Solution GmbH

Printing

Eggers Druckerei & Verlag GmbH

Editorial deadline

July 2015

Photo credits

Aurubis AG, Fotolia, Bernd Hagedorn, Beate Münchenbach, Andreas Nolte, Rolf Otzipka, Detlef Overmann, Andreas Schmidt-Wiethoff, Steffen Schulte-Lippert



The production of the Aurubis Environmental Report 2015 and the recycled paper "Circle Silk Premium White" are certified according to the criteria of the Forest Steward Council (FSC®). The FSC® issues stringent criteria for forest management and thus prevents uncontrolled logging, human rights violations and environmental strain. Since the products with the FSC® seal are passed through various steps of trade and processing, the paper processing plants, e.g. printing presses, are also certified according to FSC® standards.

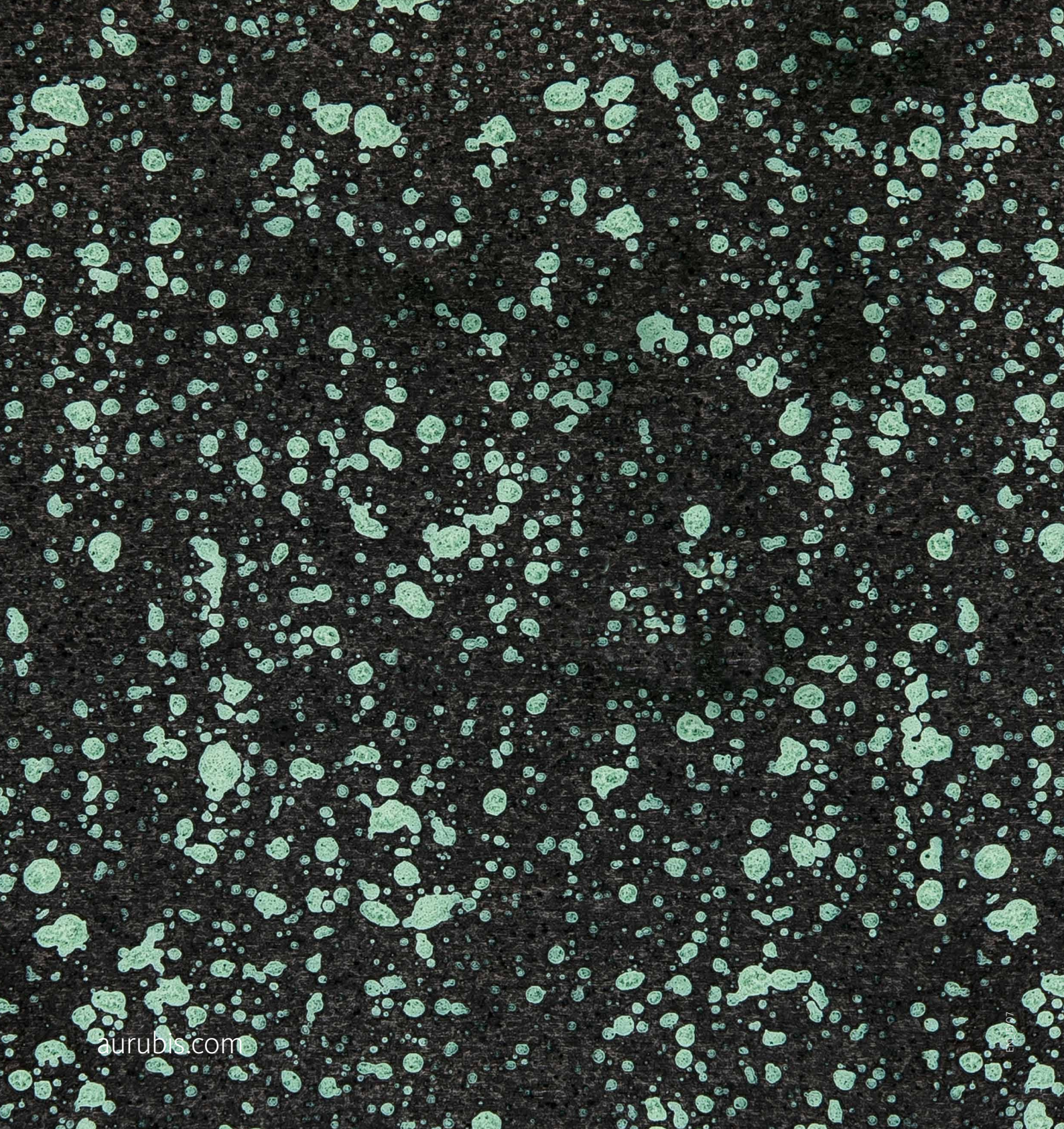

aurubis.com

EN 107

Our Copper for your Life

Aurubis AG
Hovestrass 50
D-20539 Hamburg
Phone +49 40 7883-0
Fax +49 40 7883-2255
info@aurubis.com